

Transducer-Class® Strain Gages

with Advanced Sensors Technology

Databook

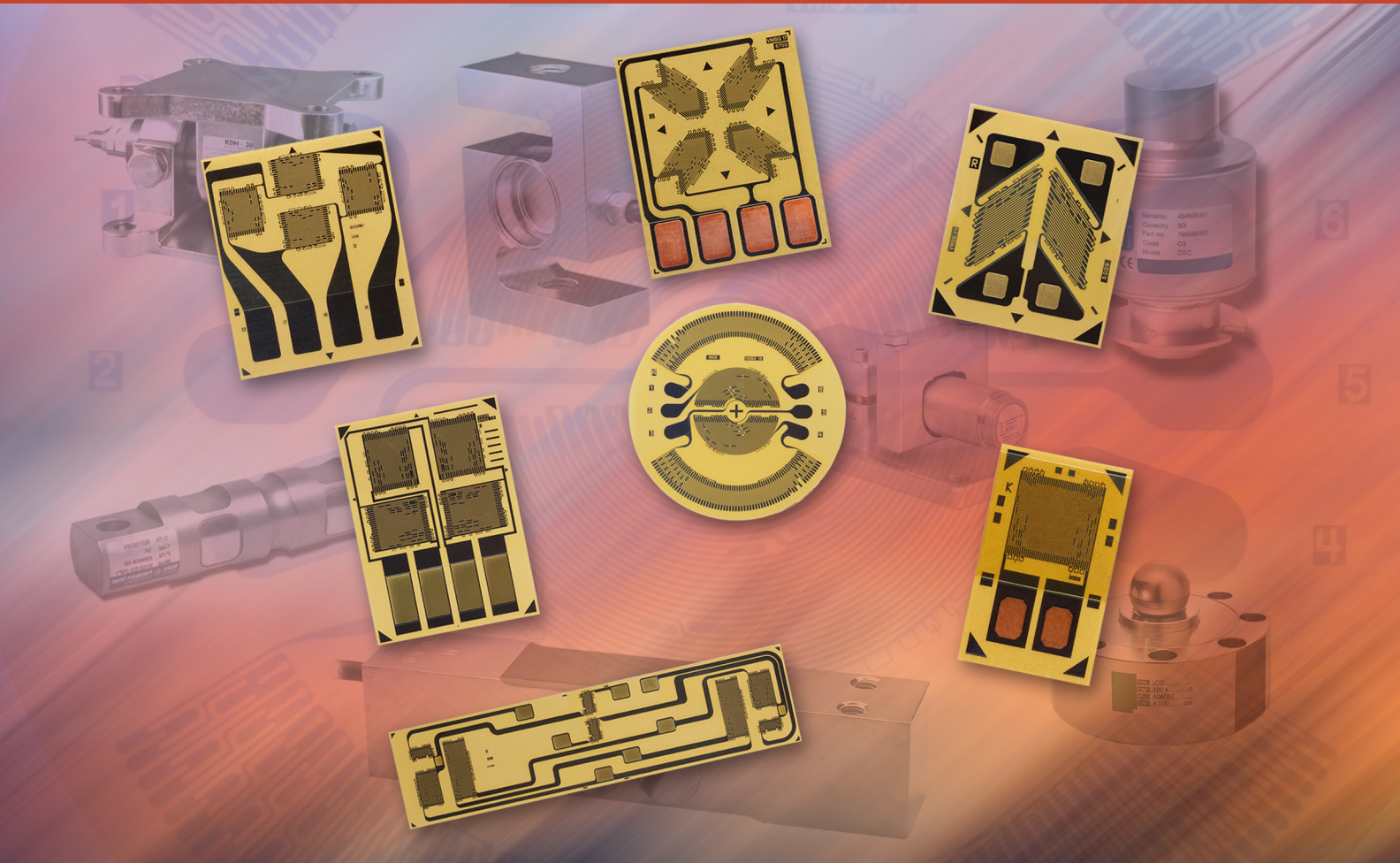

Strain Gage Sensors
Bondable Resistors
Installation Accessories

micro-measurements.com

MICRO
MEASUREMENTS
A VPG Brand

Transducer-Class[®]
**Strain Gages, Bondable Resis-
tors,
Installation Accessories**

Micro-Measurements

P.O. Box 27777

Raleigh, NC 27611

U.S.A.

Phone: +1-919-365-3800

Fax: +1-919-365-3945

www.micro-measurements.com

Disclaimer

ALL PRODUCTS, PRODUCT SPECIFICATIONS AND DATA ARE SUBJECT TO CHANGE WITHOUT NOTICE.

Vishay Precision Group, Inc., its affiliates, agents, and employees, and all persons acting on its or their behalf (collectively, "VPG"), disclaim any and all liability for any errors, inaccuracies or incompleteness contained herein or in any other disclosure relating to any product.

The product specifications do not expand or otherwise modify VPG's terms and conditions of purchase, including but not limited to, the warranty expressed therein.

VPG makes no warranty, representation or guarantee other than as set forth in the terms and conditions of purchase. **To the maximum extent permitted by applicable law, VPG disclaims (i) any and all liability arising out of the application or use of any product, (ii) any and all liability, including without limitation special, consequential or incidental damages, and (iii) any and all implied warranties, including warranties of fitness for particular purpose, non-infringement and merchantability.**

Information provided in datasheets and/or specifications may vary from actual results in different applications and performance may vary over time. Statements regarding the suitability of products for certain types of applications are based on VPG's knowledge of typical requirements that are often placed on VPG products. It is the customer's responsibility to validate that a particular product with the properties described in the product specification is suitable for use in a particular application. You should ensure you have the current version of the relevant information by contacting VPG prior to performing installation or use of the product, such as on our website at vpgsensors.com.

No license, express, implied, or otherwise, to any intellectual property rights is granted by this document, or by any conduct of VPG.

The products shown herein are not designed for use in life-saving or life-sustaining applications unless otherwise expressly indicated. Customers using or selling VPG products not expressly indicated for use in such applications do so entirely at their own risk and agree to fully indemnify VPG for any damages arising or resulting from such use or sale. Please contact authorized VPG personnel to obtain written terms and conditions regarding products designed for such applications.

Product names and markings noted herein may be trademarks of their respective owners.

TRANSDUCER-CLASS® STRAIN GAGES

General Information.....	6
Gage Series.....	8
Creep and Modulus Compensation	10
Designation System	11
Linear Patterns—Single Grid.....	12
Linear Patterns—Dual Grid	24
90° Patterns.....	33
Shear Patterns—Dual Grid.....	48
Full-Bridge Patterns	57
Linear Diaphragm Patterns.....	66
Bondable Resistors for Transducers	72
Bondable Resistor Patterns	74
Resistor Adjustment Instructions	76

M-LINE ACCESSORIES FOR TRANSDUCER APPLICATIONS

Surface Cleaning Supplies	78
M-Bond 610	80
M-Bond 43-B for Transducers.....	82
M-Bond 450	83
Installation Tools.....	84
Bondable Terminals.....	87
Solders and Accessories.....	89
Wire, Cable and Accessories	91
M-Coat A.....	96
M-Coat B.....	97
M-Coat C.....	98
M-Coat D.....	99
M-Coat FBT.....	100
M-Coat W-1.....	101
3140 RTV	102
3145 RTV	103
TAK-610 Kit	104
TransCalc™ Software.....	105

Transducer- Class[®] Strain Gages

General Information.....	6
Gage Series.....	8
Creep and Modulus Compensation	10
Designation System	11
Linear Patterns—Single Grid.....	12
Linear Patterns—Dual Grid	24
90° Patterns.....	33
Shear Patterns—Dual Grid.....	48
Full-Bridge Patterns	57
Linear Diaphragm Patterns.....	66
Bondable Resistors for Transducers	72
Bondable Resistor Patterns	74
Resistor Adjustment Instructions	76

***Transducer-Class*[®] Strain Gages with Advanced Sensors Technology**

Micro-Measurements has been a trusted name in the field of strain gage technology for more than 60 years. We are proud of our worldwide reputation as a premier supplier of high-quality precision strain gages and strain gage accessories, and are fully committed to maintaining our position as the leader in this field. This catalog of Micro-Measurements *Transducer-Class*[®] strain gages and related products for OEM applications is intended to provide an overview of the sensors and installation accessories and tools needed for successful transducer strain gage applications.

TRANSUCER-CLASS WITH ADVANCED SENSORS TECHNOLOGY

The *Transducer Class* strain gages are built with our advanced sensors technology, using state-of-the-art equipment and tooling for excellent performance and reduced lead times. Exclusive features of *Transducer-Class* gages with advanced sensors technology include:

- Excellent gage-to-gage and grid-to-grid matching, to allow for more uniform gage performance in temperature.
- Tighter resistance tolerances: down to $\pm 0.1\%$ even in high resistance gage patterns, enables simpler balance of the Wheatstone bridge circuitry.
- High resistance patterns: offered in linear, shear, tee-patterns and full-bridge configurations, with up to 10 Kohm resistance values.
- Gold-plated solder tabs (on Karma foil patterns) and epoxy encapsulation for active grid protection offered as standard features.
- Targeted to support high-volume OEM applications using state-of-the-art innovative technology.
- Optimum backing thickness tolerance, particularly important to minimize creep variations between gage installations.
- Multiple creep compensation choices for most gage patterns. A close inspection of the gage pattern reveals a small letter on the gage matrix next to the grid. This letter is the creep compensation code. Different creep compensations of the same pattern can be easily identified after removing gages from the package.
- Special pattern refinement for improved gage-to-gage reproducibility. Creep variation due to operating temperature changes is reduced.



INSTALLATION ACCESSORIES

Construction of the strain gage is completed when it is bonded and wired—final manufacturing steps that our customers undertake. To help ensure successful transducers, Micro-Measurements accessories are extensively tested before being selected for strain gage use. Clear, concise instructions are provided to make these final manufacturing steps as risk-free as possible.

APPLICATIONS ASSISTANCE

Our Transducer Applications Department is dedicated to providing accurate, friendly and confidential answers to your strain gage application questions. With a fully equipped laboratory and all of Micro-Measurements' combined engineering, manufacturing, and applications experience available to them, our Applications Engineers are "on-call" for you.

Individualized customer training is available in our Applications Laboratory or Technical Training Center in Raleigh, North Carolina USA.



Transducer-Class® Strain Gages with Advanced Sensors Technology

REFERENCE LITERATURE

Technical and product literature, along with special publications like our *Strain Gage Based Transducers* booklet, are available at no charge.



CUSTOMER SERVICE

We know that we must deliver in order for you to produce. Our Customer Service Department works daily with the individual requirements of our *Transducer-Class* customers to make sure that we supply the product you need—when you need it. Purchase conditions are tailored to your requirements, optimizing price/performance and minimizing inventory costs while ensuring the supply of reliable, high-quality strain gages and accessories.



Transducer-Class® Strain Gages with Advanced Sensors Technology

N2A SERIES

N2A gages are constantan-alloy patterns constructed on a thin, laminated, polyimide-film backing. This series is capable of low and repeatable creep performance. Construction is very rugged, which will help prevent gage handling damage. Advanced Sensors N2A gages are offered with epoxy encapsulation as standard. An open-faced version can be supplied upon request.

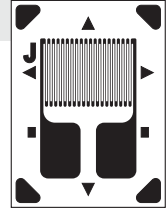

J2A SERIES

J2A gages are encapsulated constantan-alloy patterns. Both the encapsulation and backing are thin, laminated polyimide film. Gage soldering tabs are exposed for simplified lead connections. Creep performance is equal to the N2A Series, although the presence of an encapsulating layer will require a change in creep code selection to maintain the same performance.

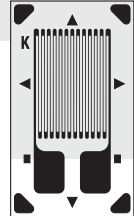

EA SERIES

EA gages are open-faced constantan-alloy patterns with a flexible cast-polyimide backing. Creep scatter is somewhat more pronounced than with all other series. Consequently, EA gages are normally available with only one creep code per pattern.

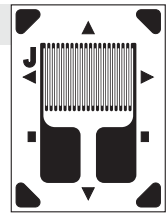

N2K SERIES

N2K gages are modified-Karma-alloy patterns constructed on a thin, laminated, polyimide-film backing. All N2K gages are supplied with gold soldering pads (DG) for ease of leadwire attachment. Copper soldering pads are also available. Most gages in the N2K Series can also be modulus compensated. Advanced Sensors N2K gages are offered with epoxy encapsulation as standard. An open-faced version can be supplied upon request.

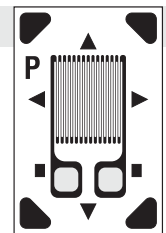

N5K SERIES

N5K gages are modified-Karma-alloy patterns constructed on a thin, laminated, polyimide-film backing constructed to improve gage performance at elevated temperatures. All N5K gages are supplied with gold soldering pads (DG) for ease of leadwire attachment. Copper soldering pads are also available. Most gages in the N5K Series can also be modulus compensated. Advanced Sensors N5K gages are offered with epoxy encapsulation as standard.

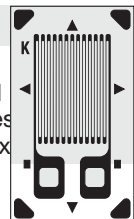

J5K SERIES

J5K gages are encapsulated, modified-Karma-alloy patterns specially constructed to improve gage performance at elevated temperatures. Because of the laminated polyimide-film backing and encapsulation, all J5K patterns are fully flexible without being brittle. Gold soldering pads (DG) as well as copper soldering pads (DP) are exposed for simplified lead connections. Some J5K gages can be supplied with modulus-compensation (EMC) options. For best high-temperature performance, J5K-Series gages should be installed with M-Bond 450 high-temperature adhesive.

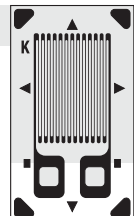

Transducer-Class[®] Strain Gages with Advanced Sensors Technology

J5E SERIES

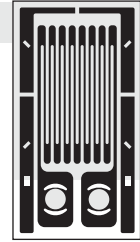

J5E gages are a family of platinum-tungsten-alloy patterns constructed with a thin, flexible polyimide backing. Sensing grids are fully encapsulated by a polyimide film overlay and include a preformed solder dot on each gage tab. With a gage factor more than double that of conventional strain gages, platinum-tungsten-alloy patterns provide standard transducer output levels at less than half the normal spring-element stress values. This allows for higher overload safety, increased fatigue life, and improved linearity in many transducer designs. A negative gage-factor-versus-temperature slope also provides modulus compensation in many types of steel transducer spring elements. A relatively high thermal output of platinum-tungsten alloy makes precision static measurements difficult. J5E gages are not manufactured with the Advanced Sensors Technology

GAGE SERIES	TEMPERATURE RANGE		GAGE FACTOR (SEE NOTE)	FATIGUE LIFE	
	STATIC	DYNAMIC		STRAIN LEVEL IN $\mu\epsilon$	NUMBER OF CYCLES
N2A	-100° to +200°F (-75° to +95°C)	Same as Static	2.05 nom.	±1500 1500	10 ⁷ 10 ⁸ ⁽²⁾
J2A	-100° to +200°F (-75° to +95°C)	Same as Static	2.05 nom.	±1700 1700	10 ⁶ 10 ⁷ ⁽²⁾
EA	-100° to +200°F (-75° to +95°C)	-320° to +350°F (-75° to +95°C)	2.05 nom.	±1500 1500	10 ⁶ 10 ⁷ ⁽²⁾
N2K	-100° to +200°F (-75° to +95°C)	Same as Static	2.1 nom. ⁽¹⁾	±1800	10 ⁷
N5K	-100° to +400°F (-75° to +205°C)	-320° to +500°F (-195° to +260°C)	2.1 nom. ⁽¹⁾	±1800	10 ⁷
J5K	-100° to +400°F (-75° to +205°C)	-320° to +500°F (-195° to +260°C)	2.1 nom. ⁽¹⁾	± 2000 1800	10 ⁷ 10 ⁸ ⁽²⁾
J5E	-100° to +400°F (-75° to +205°C)	Same as Static	4.5 nom.	±1500	10 ⁸

Notes:

Advanced Sensors gages are supplied with nominal gage factor values that will vary slightly with pattern. They are not suitable for strain measurement in stress analysis applications. Request our Precision Strain Gages databook, or contact our Applications Engineering Department, for a complete listing of gages for precision strain measurement applications.

⁽¹⁾ Nominal gage factor is 2.2 for EMC options.

⁽²⁾ Unidirectional strain.

Advanced Sensors

CREEP COMPENSATION

Commercial transducers regularly achieve a creep specification of less than $\pm 0.02\%$ of full scale (FS) for a 20-minute test. To attain this level on a high production basis, it is usually necessary to match the strain gage's creep characteristic to the spring element creep.

Most *Transducer-Class* gages can be adjusted in design to exhibit either a positive or negative creep under load. Spring element materials exhibit only positive creep under load. (See figure below.)

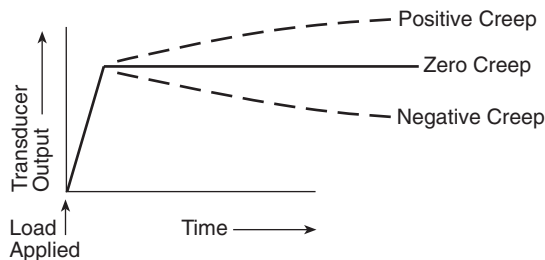

Since transducer creep depends on several variables such as spring element material, heat treatment, strain field, adhesive type and test temperature, it is not possible to predict the proper gage compensation necessary to achieve the best creep result.

Most of the gages in this catalog list one available creep compensation code. Since it is not possible to predetermine the creep characteristics of a particular transducer, it is suggested that the standard creep code be ordered in quantities sufficient to evaluate three or four transducers. Where creep levels are high enough to warrant correction, a different creep compensation, either more negative or more positive, depending on test results, can often be recommended.

A complicating factor in creep code selection is that while different gage patterns may list the same creep code, they do not necessarily exhibit the same creep behavior. This is because the gage backing selection, gridline width and gage length also influence creep characteristics.

It should also be noted that this type of creep correction is generally limited to transducers exhibiting less than $\pm 0.1\%$ FS creep. Higher creep levels in the positive direction are often the result of poor spring element material selection. Negative creep values in excess of 0.1% FS generally are the result of a faulty gage installation.

MODULUS COMPENSATION (EMC) OPTION

Many of the K-alloy gages in this catalog are available in a special form which permits the gage factor change with temperature to be adjusted over a wide range during gage manufacture.

Properly matched to the transducer spring element, these EMC (Effective Modulus Compensation) gages can provide very good self-correction of changes in transducer span versus temperature. A compensation better than $\pm 0.0008\%/^{\circ}\text{F}$ ($\pm 0.0014\%/^{\circ}\text{C}$) can readily be achieved in many cases.

While this may at first appear to be the "ideal" strain gage for transducers, there are certain factors that should be considered prior to selecting EMC gages for a given application:

1. EMC gages cost more than other gages. In most cases the difference is great enough to offset the additional cost of span/temperature resistors.
2. EMC gages must be "matched" to the transducer spring material. Depending on the degree of compensation accuracy desired, the standard EMC options may not yield the "best fit" compensation on the spring material in use. In these cases, a special foil lot which possesses the desired compensation would be required. There is normally a minimum order requirement and set-up charge for special foil lots.
3. Transducer spring materials may not have batch-to-batch repeatability sufficient to maintain specifications when using the same EMC gages. New material lot testing is therefore necessary for high precision units.

Despite these limitations, EMC gages can often be advantageous for transducer manufacturers.

The following standard EMC options are available:

OPTION M1

Gage factor slope is -1.50% per 100°F (-2.70% per 100°C). Provides span-versus-temperature compensation for many stainless steels.

OPTION M2

Gage factor slope is -2.35% per 100°F (-4.23% per 100°C). Provides span-versus-temperature compensation for most aluminum alloys.

OPTION M3



Gage factor slope is -1.25% per 100°F (-2.25% per 100°C). Provides span-versus-temperature compensation for many tool steels.

OPTION M4

Gage factor slope is -1.35% per 100°F (-2.43% per 100°C). Provides "mid-range" compensation between M1 and M3.

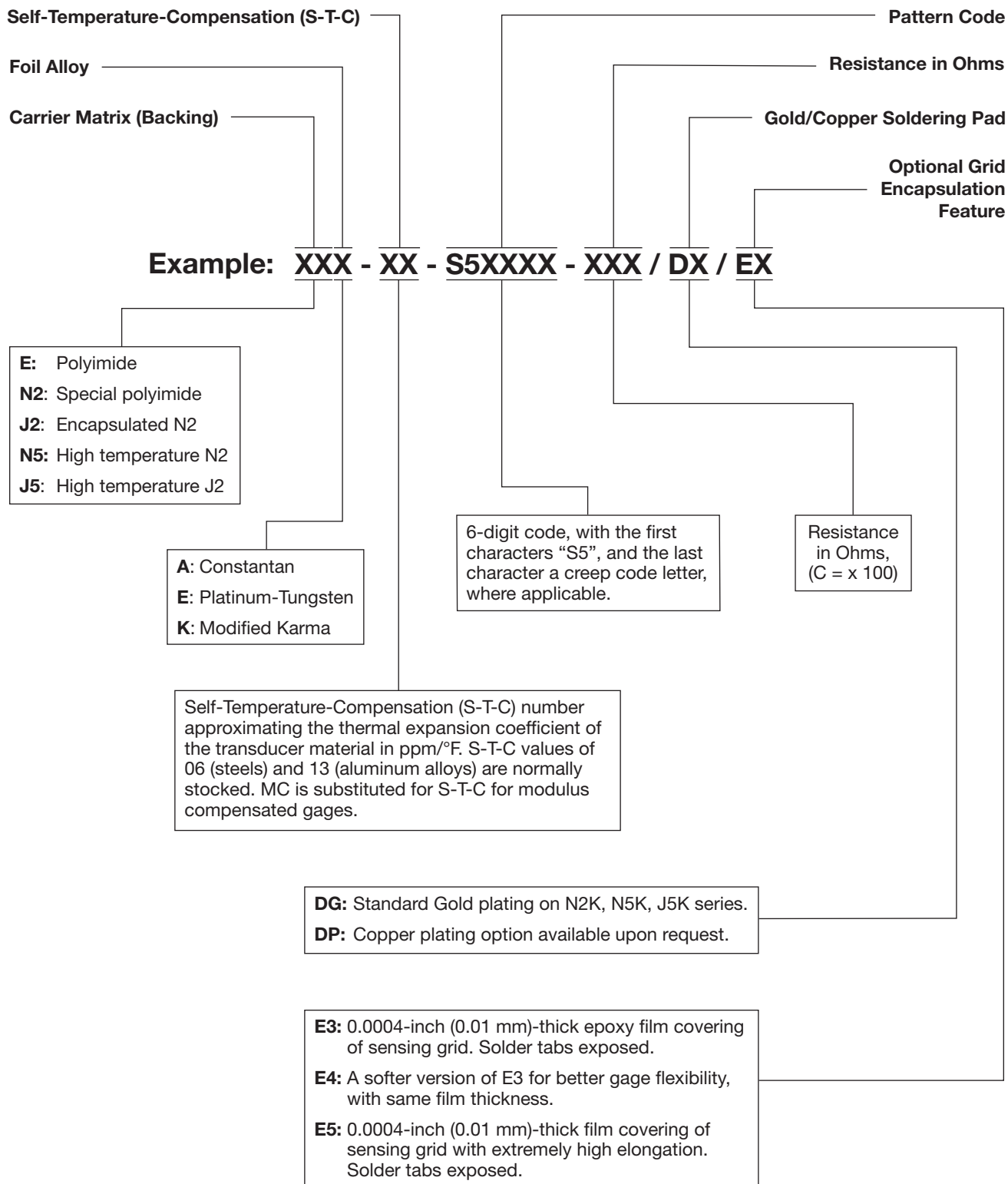

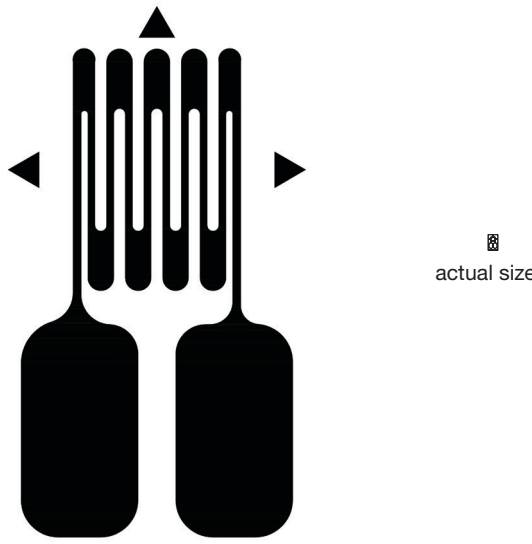
Transducer-Class® Strain Gages with Advanced Sensors Technology



S5272 GAGE PATTERN DATA			
 <p>actual size</p>	GAGE DESIGNATION	RESISTANCE IN OHMS	STD. CREEP CODE
	N2A-XX-S5272H-120/E4	120 ±0.5%	H*
DESCRIPTION			
General-purpose miniature pattern 120 Ω.			

GAGE DIMENSIONS						inch	millimeter
Grid Length	Overall Length	Grid Width	Overall Width	Matrix Length	Matrix Width		
0.015	0.062	0.020	0.037	0.08	0.05		
0.38	1.57	0.51	0.93	2.1	1.2		

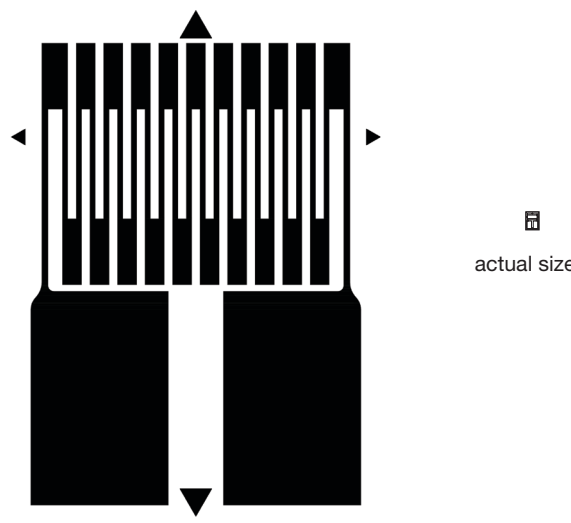

* Only creep code available for this gage.

S5077 GAGE PATTERN DATA			
 <p>actual size</p>	GAGE DESIGNATION	RESISTANCE IN OHMS	STD. CREEP CODE
	N2K-XX-S5077T-350/DG/E5 N5K-XX-S5077T-350/DG/E5	350 ±0.2% 350 ±0.2%	T T
DESCRIPTION			
General-purpose miniature pattern 350 Ω.			

GAGE DIMENSIONS						inch	millimeter
Grid Length	Overall Length	Grid Width	Overall Width	Matrix Length	Matrix Width		
0.020	0.089	0.060	0.060	0.10	0.07		
0.51	2.26	1.52	1.52	2.5	1.8		

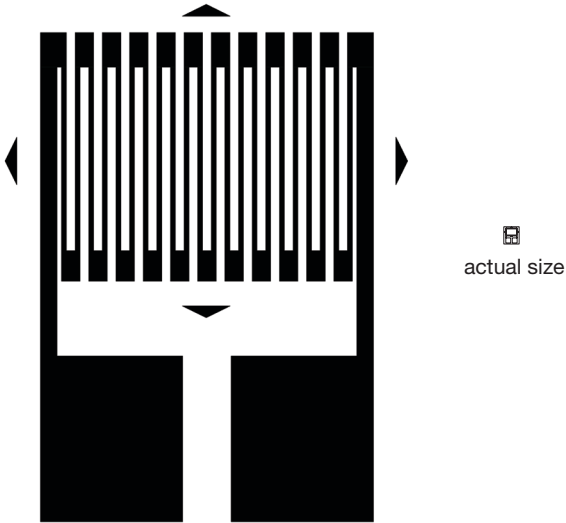

Copper plating for tabs is available.

Transducer-Class® Strain Gages with Advanced Sensors Technology

S5037 GAGE PATTERN DATA			
	GAGE DESIGNATION	RESISTANCE IN OHMS	STD. CREEP CODE
	N2K-XX-S5037Q-10C/DG/E5 N5K-XX-S5037Q-10C/DG/E5	1000 ±0.2% 1000 ±0.2%	Q Q
DESCRIPTION Miniature high resistance pattern.			 RoHS COMPLIANT

GAGE DIMENSIONS					
				inch	millimeter
Grid Length	Overall Length	Grid Width	Overall Width	Matrix Length	Matrix Width
0.034	0.087	0.051	0.056	0.09	0.08
0.86	2.21	1.30	1.42	2.4	1.9

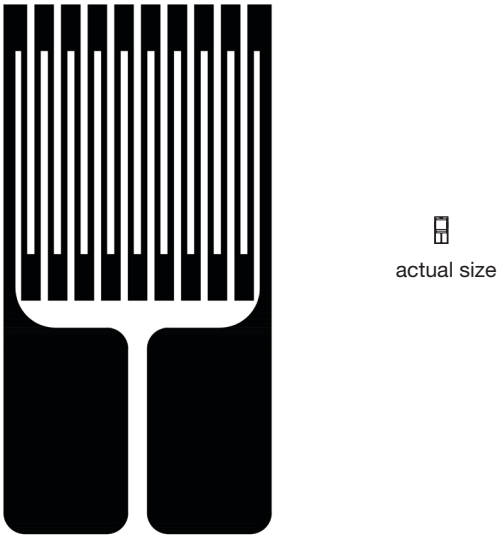

Copper plating for tabs is available.

S5126 GAGE PATTERN DATA			
	GAGE DESIGNATION	RESISTANCE IN OHMS	STD. CREEP CODE
	N2K-XX-S5126S-350/DG/E3 N5K-XX-S5126S-350/DG/E3	350 ±0.2% 350 ±0.2%	S* S*
DESCRIPTION General-purpose miniature pattern.			 RoHS COMPLIANT

GAGE DIMENSIONS					
				inch	millimeter
Grid Length	Overall Length	Grid Width	Overall Width	Matrix Length	Matrix Width
0.050	0.131	0.065	0.065	0.14	0.07
1.27	3.32	1.65	1.65	3.5	1.9

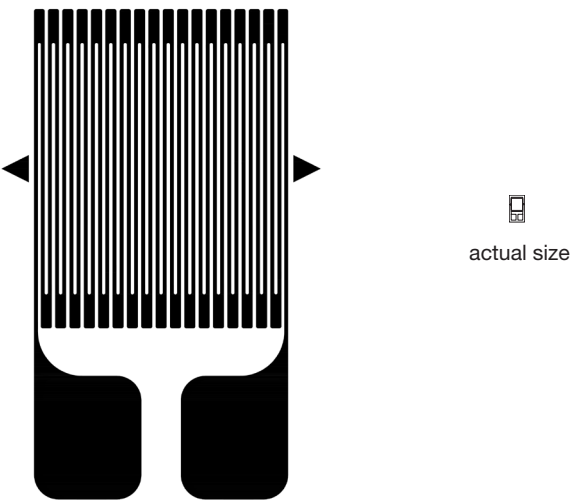

* Only creep code available for this gage.
Copper plating for tabs is available.

Transducer-Class® Strain Gages with Advanced Sensors Technology

S5262 GAGE PATTERN DATA			
	GAGE DESIGNATION	RESISTANCE IN OHMS	STD. CREEP CODE
	N2A-XX-S5262P-350/E4	350 ±0.15%	P*
DESCRIPTION General-purpose miniature pattern.			 RoHS COMPLIANT

GAGE DIMENSIONS						inch	millimeter
Grid Length	Overall Length	Grid Width	Overall Width	Matrix Length	Matrix Width		
0.062	0.120	0.062	0.062	0.14	0.08		
1.57	3.04	1.57	1.57	3.5	2.1		

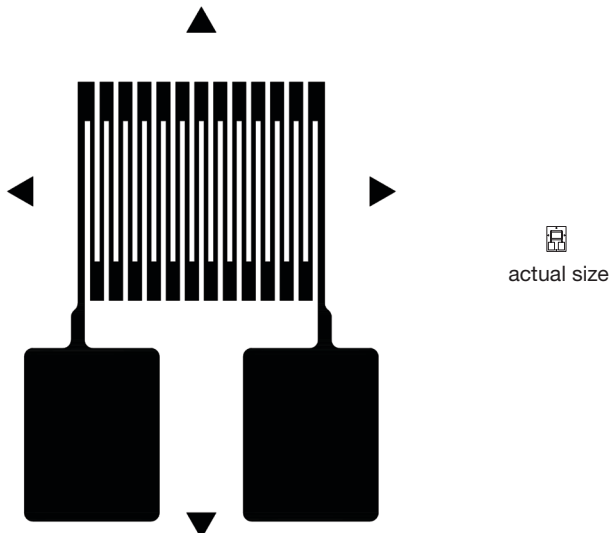

* Only creep code available for this gage.

S5094 GAGE PATTERN DATA			
	GAGE DESIGNATION	RESISTANCE IN OHMS	STD. CREEP CODE
	N2K-XX-S5094Q-10C/DG/E5 N5K-XX-S5094Q-10C/DG/E5	1000 ±0.2% 1000 ±0.2%	Q* Q*
DESCRIPTION Same grid size as the S5037, with larger solder tabs.			 RoHS COMPLIANT

GAGE DIMENSIONS						inch	millimeter
Grid Length	Overall Length	Grid Width	Overall Width	Matrix Length	Matrix Width		
0.033	0.104	0.054	0.084	0.13	0.10		
0.85	2.64	1.38	2.13	3.4	2.5		

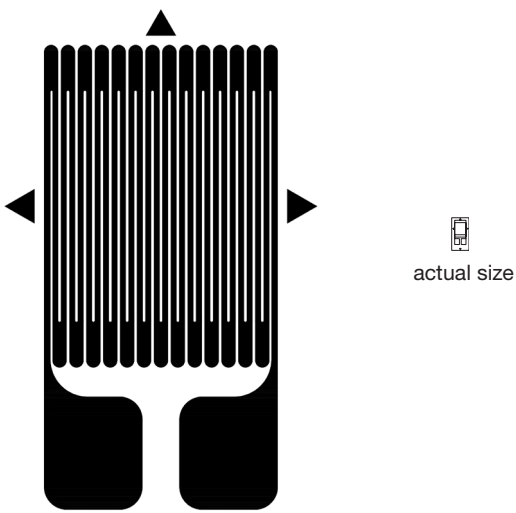

* Only creep code available for this gage.
Copper plating for tabs is available.

Transducer-Class® Strain Gages with Advanced Sensors Technology

S5199 GAGE PATTERN DATA			
 <p>actual size</p>	GAGE DESIGNATION N2K-XX-S5199T-350/DG/E4 N5K-XX-S5199T-350/DG/E4	RESISTANCE IN OHMS 350 ±0.15% 350 ±0.15%	STD. CREEP CODE T T
	DESCRIPTION Narrow version of the S5156.		 RoHS COMPLIANT

GAGE DIMENSIONS					
				inch	millimeter
Grid Length	Overall Length	Grid Width	Overall Width	Matrix Length	Matrix Width
0.062	0.124	0.062	0.062	0.17	0.09
1.57	3.14	1.57	1.57	4.3	2.4

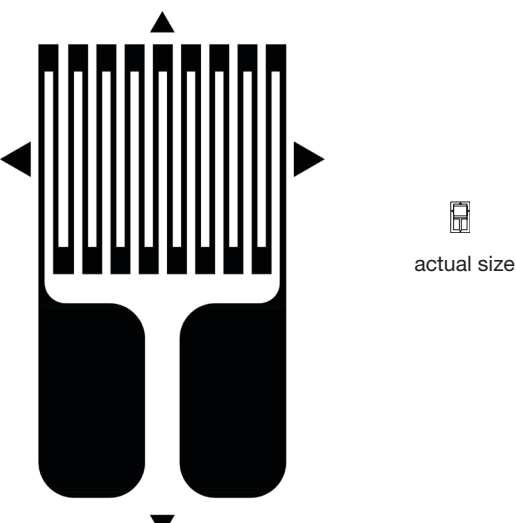

Copper plating for tabs is available.

S5182 GAGE PATTERN DATA			
 <p>actual size</p>	GAGE DESIGNATION N2A-XX-S5182N-10C/E4	RESISTANCE IN OHMS 1000 ±0.2%	STD. CREEP CODE N*
	DESCRIPTION Miniature high resistance pattern.		 RoHS COMPLIANT

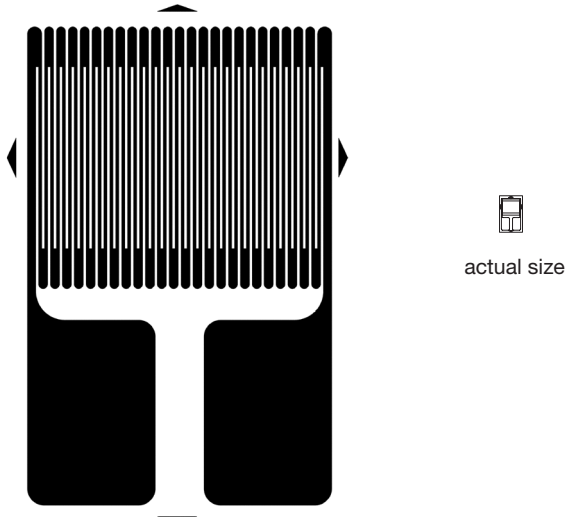

GAGE DIMENSIONS					
				inch	millimeter
Grid Length	Overall Length	Grid Width	Overall Width	Matrix Length	Matrix Width
0.050	0.129	0.070	0.070	0.16	0.10
1.27	3.26	1.78	1.78	4.0	2.5

* Only creep code available for this gage.

Transducer-Class® Strain Gages with Advanced Sensors Technology

GAGE PATTERN DATA			
	GAGE DESIGNATION N2A-XX-S5091R-350/E3 N2A-XX-S5128P-10C/E4	RESISTANCE IN OHMS 350 ±0.2% 1000 ±0.2%	STD. CREEP CODE R P
	DESCRIPTION The most popular small gage pattern.		

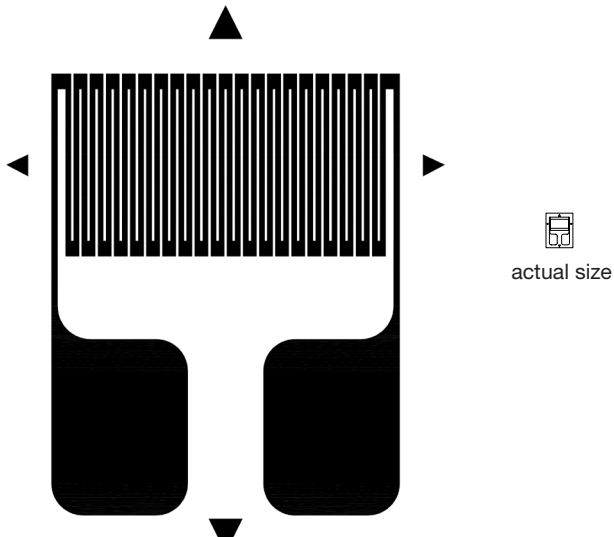

GAGE DIMENSIONS						inch	millimeter
Grid Length	Overall Length	Grid Width	Overall Width	Matrix Length	Matrix Width		
0.060	0.154	0.100	0.100	0.19	0.12		
1.52	3.89	2.54	2.54	4.7	3.0		

S5063 GAGE PATTERN DATA			
	GAGE DESIGNATION N2K-XX-S5063G-350/DG/E5 N5K-XX-S5063G-350/DG/E5	RESISTANCE IN OHMS 350 ±0.15% 350 ±0.15%	STD. CREEP CODE G* G*
	DESCRIPTION One of the most popular gage sizes.		

GAGE DIMENSIONS						inch	millimeter
Grid Length	Overall Length	Grid Width	Overall Width	Matrix Length	Matrix Width		
0.047	0.137	0.100	0.108	0.18	0.14		
1.19	3.48	2.55	2.75	4.5	3.7		

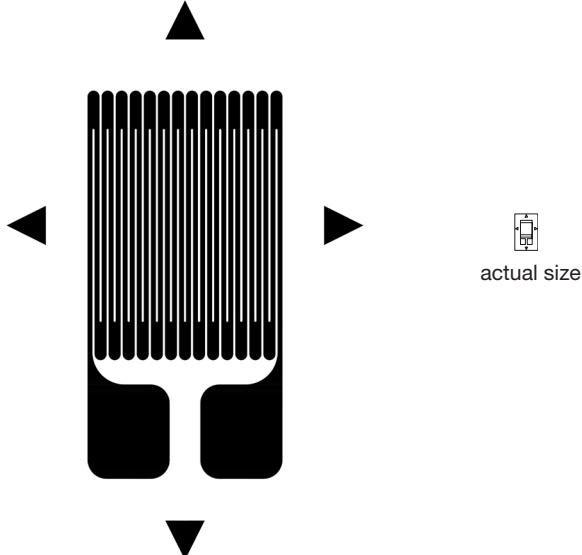

* Only creep code available for this gage.
Copper plating for tabs is available.

Transducer-Class® Strain Gages with Advanced Sensors Technology

GAGE PATTERN DATA			
	GAGE DESIGNATION N2A-XX-S5155Q-350/E4 N2K-XX-S5156T-350/DG/E4 N5K-XX-S5156T-350/DG/E4	RESISTANCE IN OHMS 350 ±0.15% 350 ±0.15% 350 ±0.15%	STD. CREEP CODE Q* T* T*
	DESCRIPTION General-purpose miniature patterns.		

GAGE DIMENSIONS					
				inch	millimeter
Grid Length	Overall Length	Grid Width	Overall Width	Matrix Length	Matrix Width
0.062	0.124	0.062	0.062	0.19	0.12
1.57	3.14	1.57	1.57	4.7	3.1

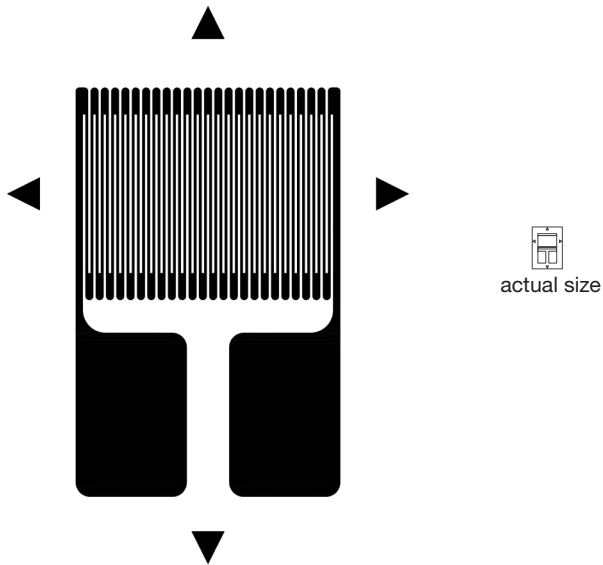

* Only creep code available for this gage.
Copper plating for tabs when available.

GAGE PATTERN DATA			
	GAGE DESIGNATION N2K-XX-S5301R-175/DP/E4 N5K-XX-S5301R-175/DP/E4 N2A-XX-S5178R-350/E4 N2K-XX-S5114Q-350/DG/E4 N5K-XX-S5114Q-350/DG/E4 N2K-XX-S5171Q-10C/DG/E4 N5K-XX-S5171Q-10C/DG/E4	RESISTANCE IN OHMS 175 ±0.15% 175 ±0.15% 350 ±0.2% 350 ±0.2% 1000 ±0.2% 1000 ±0.2%	STD. CREEP CODE R* R* R Q Q Q* Q*
	DESCRIPTION The most popular small gage pattern.		

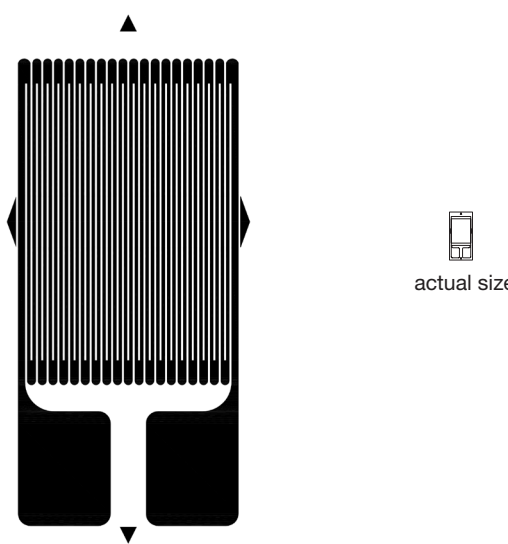

GAGE DIMENSIONS					
				inch	millimeter
Grid Length	Overall Length	Grid Width	Overall Width	Matrix Length	Matrix Width
0.060	0.150	0.100	0.100	0.22	0.16
1.52	3.80	2.54	2.54	5.6	4.1

* Only creep code available for this gage.
Copper plating for tabs when applicable.

Transducer-Class® Strain Gages with Advanced Sensors Technology

S5105 GAGE PATTERN DATA			
	GAGE DESIGNATION	RESISTANCE IN OHMS	STD. CREEP CODE
	N2A-XX-S5105R-350/E5	350 ±0.2%	R
DESCRIPTION One of the most popular gage sizes.			

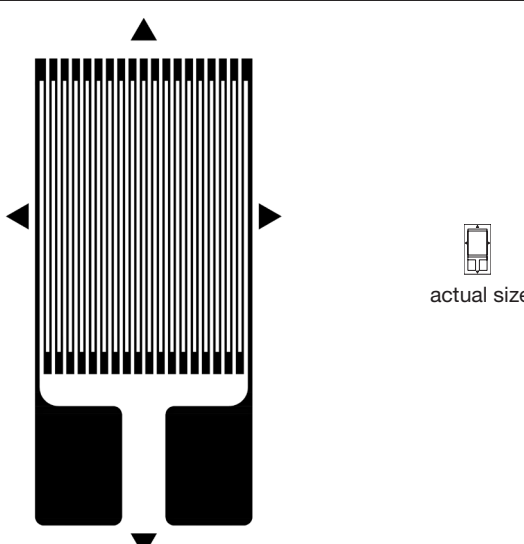

GAGE DIMENSIONS					
				inch	millimeter
Grid Length	Overall Length	Grid Width	Overall Width	Matrix Length	Matrix Width
0.126	0.212	0.100	0.100	0.25	0.12
3.20	5.35	2.54	2.54	6.3	3.0

S5150 GAGE PATTERN DATA			
	GAGE DESIGNATION	RESISTANCE IN OHMS	STD. CREEP CODE
	N2A-XX-S5150R-10C/E4	1000 ±0.2%	R*
DESCRIPTION One of the most popular gage sizes.			

GAGE DIMENSIONS					
				inch	millimeter
Grid Length	Overall Length	Grid Width	Overall Width	Matrix Length	Matrix Width
0.125	0.215	0.100	0.100	0.26	0.14
3.18	5.45	2.54	2.54	6.6	3.5

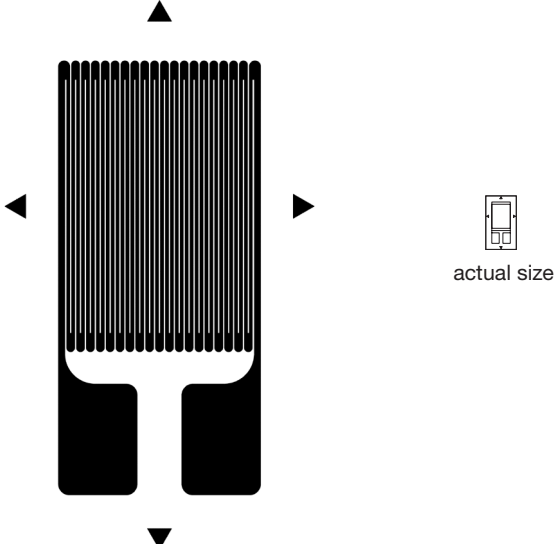

* Only creep code available for this gage.

Transducer-Class® Strain Gages with Advanced Sensors Technology

GAGE PATTERN DATA			
 <p>actual size</p>	GAGE DESIGNATION	RESISTANCE IN OHMS	STD. CREEP CODE
	N2A-XX-S5122R-350/E4	350 ±0.15%	R
	N2A-XX-S5286R-120/E5	120 ±0.2%	R*
	N2K-XX-S5109Q-350/DG/E4	350 ±0.2%	Q
	N5K-XX-S5109Q-350/DG/E4	350 ±0.2%	Q
DESCRIPTION One of the most popular gage sizes.			 RoHS COMPLIANT

GAGE DIMENSIONS					
				inch	millimeter
Grid Length	Overall Length	Grid Width	Overall Width	Matrix Length	Matrix Width
0.125	0.215	0.100	0.100	0.28	0.16
3.18	5.45	2.54	2.54	7.1	4.1

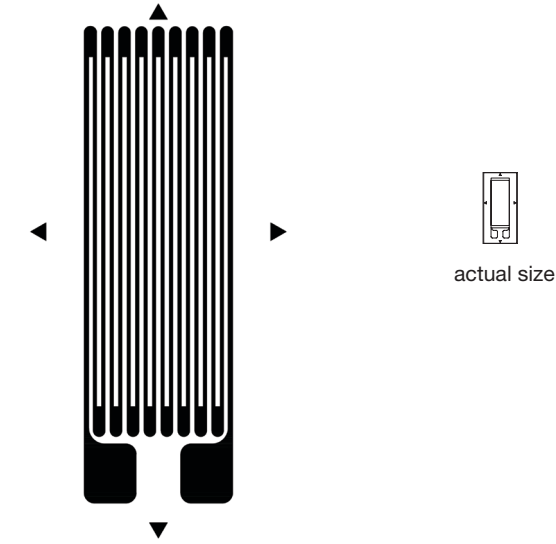

* Only creep code available for this gage.
Copper plating for tabs when applicable.

S5148 GAGE PATTERN DATA			
 <p>actual size</p>	GAGE DESIGNATION	RESISTANCE IN OHMS	STD. CREEP CODE
	N2A-XX-S5148X-350/E5	350 ±0.2%	X*
DESCRIPTION Longer grid for strain averaging or where higher power dissipation is required.			 RoHS COMPLIANT

GAGE DIMENSIONS					
				inch	millimeter
Grid Length	Overall Length	Grid Width	Overall Width	Matrix Length	Matrix Width
0.236	0.316	0.100	0.100	0.37	0.18
5.99	8.02	2.54	2.54	9.3	4.6

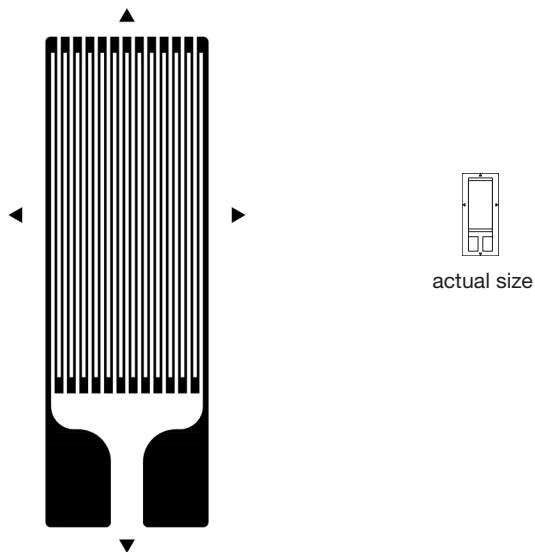

* Only creep code available for this gage.

Transducer-Class® Strain Gages with Advanced Sensors Technology

S5117 GAGE PATTERN DATA			
 <p>actual size</p>	GAGE DESIGNATION N2K-XX-S5117T-10C/DG/E5 N5K-XX-S5117T-10C/DG/E5	RESISTANCE IN OHMS 1000 ±0.2% 1000 ±0.2%	STD. CREEP CODE T* T*
	DESCRIPTION Large grid and high resistance permit higher-than-normal excitation voltage.		

GAGE DIMENSIONS						inch	millimeter
Grid Length	Overall Length	Grid Width	Overall Width	Matrix Length	Matrix Width		
0.250	0.377	0.125	0.125	0.43	0.19		
6.35	9.57	3.18	3.18	10.8	4.8		

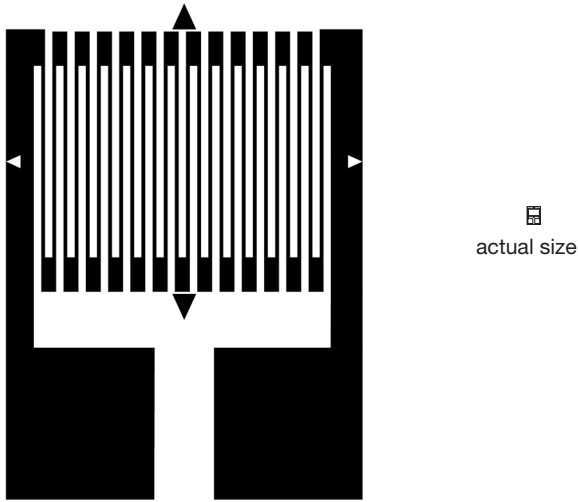

* Only creep code available for this gage.
Copper plating for tabs is available.

S5024 GAGE PATTERN DATA			
 <p>actual size</p>	GAGE DESIGNATION N2K-XX-S5024G-50C/DG/E5 N5K-XX-S5024G-50C/DG/E5	RESISTANCE IN OHMS 5000 ±0.2% 5000 ±0.2%	STD. CREEP CODE G G
	DESCRIPTION Miniature 5000 Ω linear gage. Can be used in 4 mA to 20 mA transmitters and battery-operated transducers.		

GAGE DIMENSIONS						inch	millimeter
Grid Length	Overall Length	Grid Width	Overall Width	Matrix Length	Matrix Width		
0.026	0.064	0.048	0.048	0.07	0.06		
0.66	1.60	1.22	1.22	1.9	1.4		

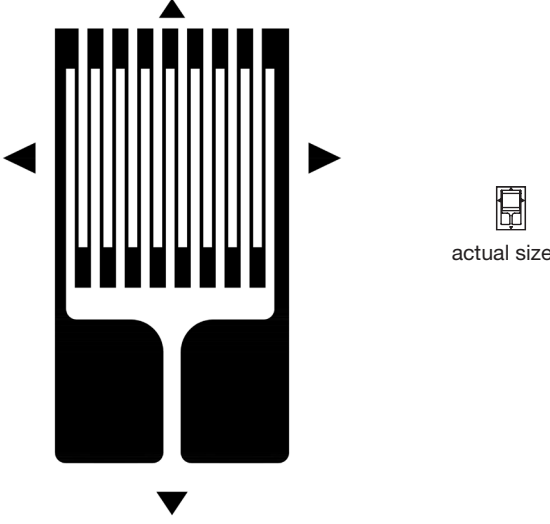

Copper plating for tabs is available.

Transducer-Class® Strain Gages with Advanced Sensors Technology

S5120 GAGE PATTERN DATA			
	GAGE DESIGNATION	RESISTANCE IN OHMS	STD. CREEP CODE
	N2K-XX-S5120S-25C/DG/E5 N5K-XX-S5120S-25C/DG/E5	2500 ±0.2% 2500 ±0.2%	S* S*
DESCRIPTION			 RoHS COMPLIANT
Widely used in 4 mA to 20 mA transmitters and battery-operated transducers.			

GAGE DIMENSIONS					
				inch	millimeter
Grid Length	Overall Length	Grid Width	Overall Width	Matrix Length	Matrix Width
0.050	0.121	0.065	0.070	0.15	0.10
1.27	3.07	1.65	1.78	3.9	2.6

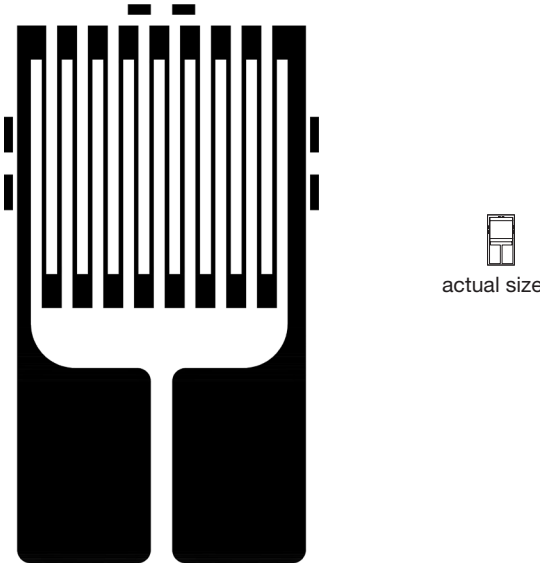

* Only creep code available for this gage.
Copper plating for tabs is available.

S5044 GAGE PATTERN DATA			
	GAGE DESIGNATION	RESISTANCE IN OHMS	STD. CREEP CODE
	N2K-XX-S5044Q-50C/DG/E5 N5K-XX-S5044Q-50C/DG/E5	5000 ±0.2% 5000 ±0.2%	Q Q
DESCRIPTION			 RoHS COMPLIANT
Similar grid to S5030 with smaller matrix size. Widely used in 4 mA to 20 mA transmitters and battery-operated transducers.			

GAGE DIMENSIONS					
				inch	millimeter
Grid Length	Overall Length	Grid Width	Overall Width	Matrix Length	Matrix Width
0.050	0.129	0.065	0.065	0.14	0.08
1.27	3.27	1.65	1.65	3.6	1.9

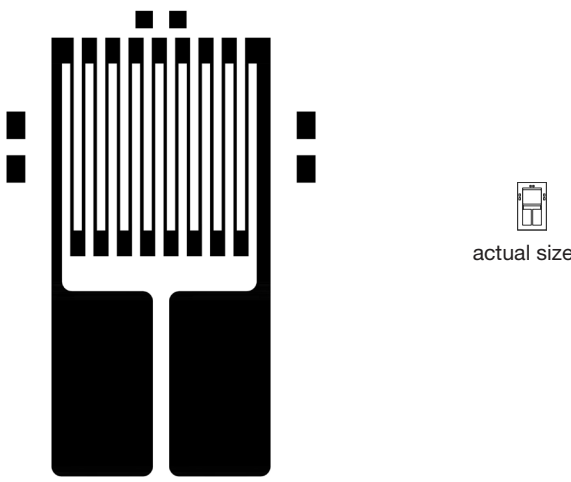

Copper plating for tabs is available.

Transducer-Class® Strain Gages with Advanced Sensors Technology

S5030 GAGE PATTERN DATA			
	GAGE DESIGNATION	RESISTANCE IN OHMS	STD. CREEP CODE
	N2K-XX-S5030K-50C/DG/E5 N5K-XX-S5030K-50C/DG/E5	5000 ±0.2% 5000 ±0.2%	K K
DESCRIPTION Widely used in 4 mA to 20 mA transmitters and battery-operated transducers.			 RoHS COMPLIANT

GAGE DIMENSIONS						inch	millimeter
Grid Length	Overall Length	Grid Width	Overall Width	Matrix Length	Matrix Width		
0.050	0.129	0.065	0.065	0.17	0.10		
1.27	3.27	1.66	1.66	4.2	2.5		

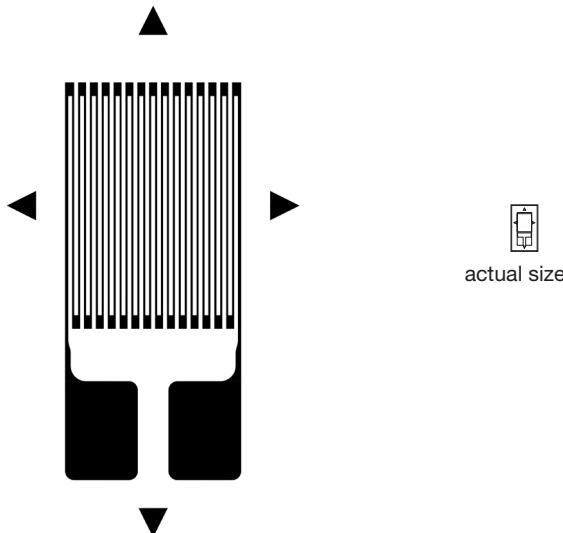

Copper plating for tabs is available.

S5029 GAGE PATTERN DATA			
	GAGE DESIGNATION	RESISTANCE IN OHMS	STD. CREEP CODE
	N2K-XX-S5029L-45C/DG/E5 N5K-XX-S5029L-45C/DG/E5	4500 ±0.2% 4500 ±0.2%	L L
DESCRIPTION Larger grid pattern than the S5030.			 RoHS COMPLIANT

GAGE DIMENSIONS						inch	millimeter
Grid Length	Overall Length	Grid Width	Overall Width	Matrix Length	Matrix Width		
0.100	0.182	0.080	0.080	0.25	0.14		
2.54	4.60	2.03	2.03	6.3	3.5		

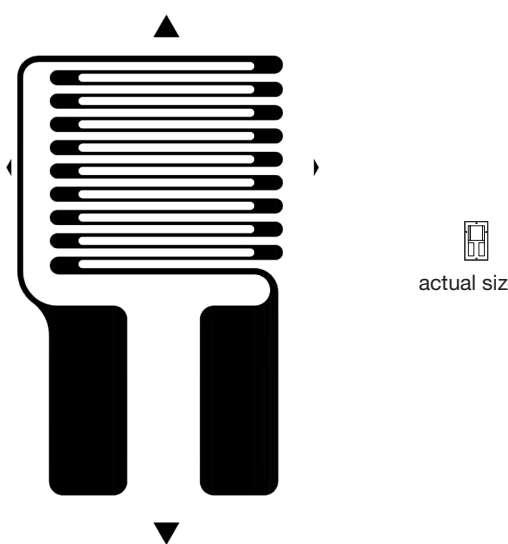

* Only creep code available for this gage.
Copper plating for tabs is available.

Transducer-Class[®] Strain Gages with Advanced Sensors Technology

S5212 GAGE PATTERN DATA			
	GAGE DESIGNATION	RESISTANCE IN OHMS	STD. CREEP CODE
	N2A-XX-S5212R-20C/E5	2000 ±0.2%	R*
DESCRIPTION Constantan pattern, with solder tabs in 90° to grid.			 RoHS COMPLIANT

GAGE DIMENSIONS					
				inch	millimeter
Grid Length	Overall Length	Grid Width	Overall Width	Matrix Length	Matrix Width
0.063	0.082	0.075	0.155	0.12	0.20
1.60	2.08	1.91	3.93	3.0	5.0

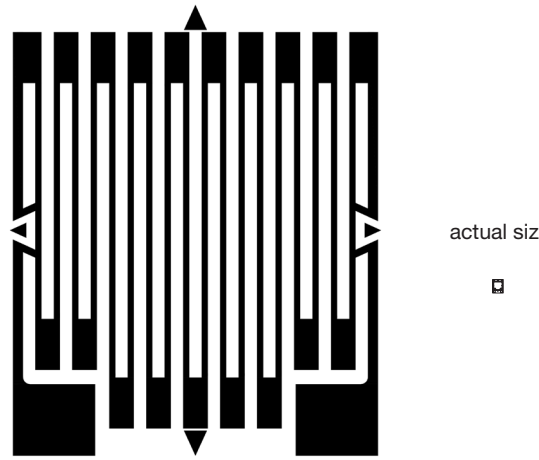

* Only creep code available for this gage.

S5032 GAGE PATTERN DATA			
	GAGE DESIGNATION	RESISTANCE IN OHMS	STD. CREEP CODE
	N2K-XX-S5032M-10C/DG/E5 N5K-XX-S5032M-10C/DG/E5	10000 ±0.2% 10000 ±0.2%	M M
DESCRIPTION Miniature 10000 Ω linear gage. Can be used in 4 mA to 20 mA transmitters and battery-operated transducers.			 RoHS COMPLIANT

GAGE DIMENSIONS					
				inch	millimeter
Grid Length	Overall Length	Grid Width	Overall Width	Matrix Length	Matrix Width
0.040	0.061	0.048	0.048	0.07	0.06
1.02	1.55	1.22	1.22	1.8	1.4

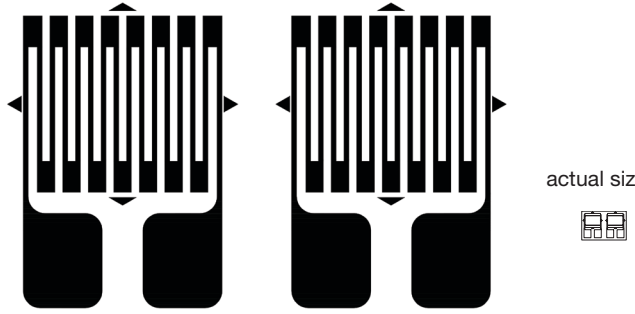

Copper plating for tabs is available.

Transducer-Class® Strain Gages with Advanced Sensors Technology

S5100 GAGE PATTERN DATA			
 <p>actual size</p>	GAGE DESIGNATION N2K-XX-S5100Q-10C/DG/E5 N5K-XX-S5100Q-10C/DG/E5	RESISTANCE IN OHMS 1000 ±0.2% 1000 ±0.2%	STD. CREEP CODE Q* Q*
	DESCRIPTION Small dual-element gage designed for bending-beam transducers.		 RoHS COMPLIANT

GAGE DIMENSIONS					
				inch	millimeter
Grid Length	Overall Length	Grid Width	Overall Width	Matrix Length	Matrix Width
0.033	0.086	0.054	0.139	0.10	0.15
0.85	2.18	1.38	3.52	2.5	3.9

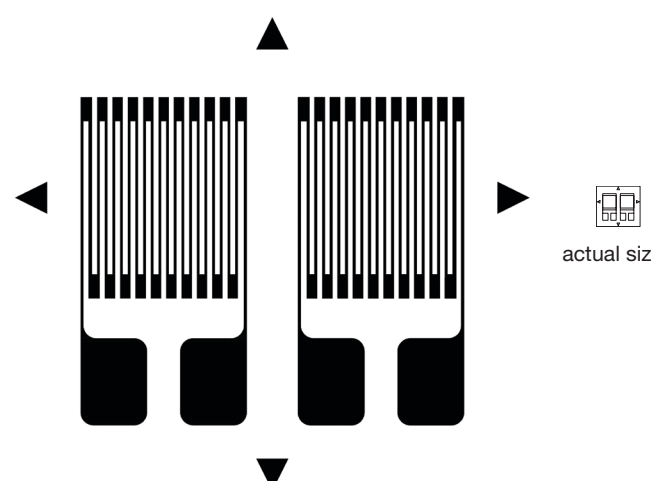

* Only creep code available for this gage.
Copper plating for tabs is available.

S5081 GAGE PATTERN DATA			
 <p>actual size</p>	GAGE DESIGNATION N2K-XX-S5081Q-10C/DG/E4 N5K-XX-S5081Q-10C/DG/E4	RESISTANCE IN OHMS 1000 ±0.2% 1000 ±0.2%	STD. CREEP CODE Q* Q*
	DESCRIPTION Small dual-element gage designed for bending-beam transducers.		 RoHS COMPLIANT

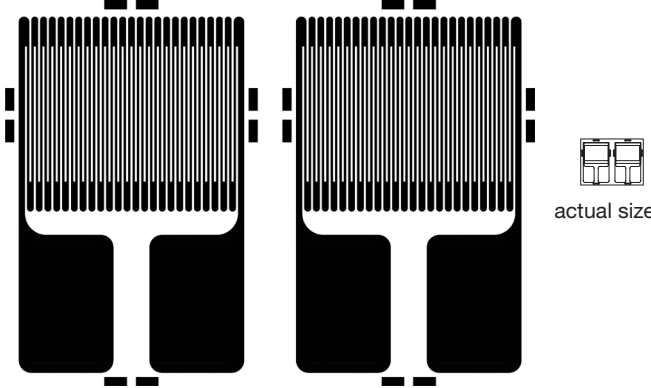

GAGE DIMENSIONS					
				inch	millimeter
Grid Length	Overall Length	Grid Width	Overall Width	Matrix Length	Matrix Width
0.060	0.128	0.065	0.150	0.19	0.21
1.52	3.25	1.65	3.81	4.9	5.3

* Only creep code available for this gage.
Copper plating for tabs is available.

Transducer-Class® Strain Gages with Advanced Sensors Technology

GAGE PATTERN DATA			
 <p>actual size</p>	GAGE DESIGNATION	RESISTANCE IN OHMS	STD. CREEP CODE
	N2A-XX-S5092R-350/E4 N2A-XX-S5127P-10C/E4	350 ±0.2% 1000 ±0.2%	R P
DESCRIPTION Small dual-element gage designed for bending-beam transducers.			 RoHS COMPLIANT

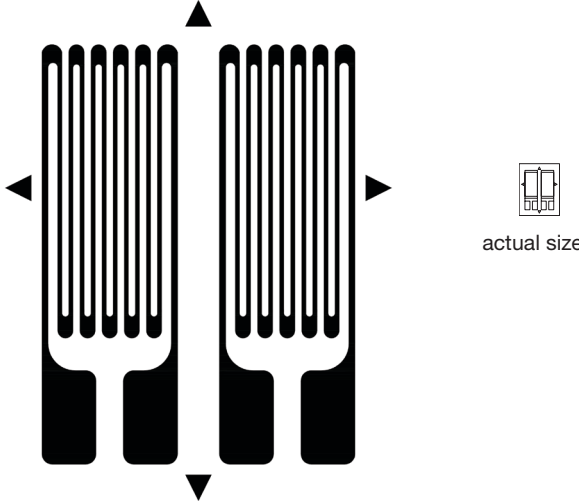

GAGE DIMENSIONS						inch	millimeter
Grid Length	Overall Length	Grid Width	Overall Width	Matrix Length	Matrix Width		
0.060	0.154	0.100	0.223	0.18	0.24		
1.52	3.89	2.54	5.66	4.7	6.2		

S5377 GAGE PATTERN DATA			
 <p>actual size</p>	GAGE DESIGNATION	RESISTANCE IN OHMS	STD. CREEP CODE
	N2K-XX-S5377R-350/DG/E4 N5K-XX-S5377R-350/DG/E4	350 ±0.2% 350 ±0.2%	R* R*
DESCRIPTION Dual-element gages widely used on bending-beam transducers.			 RoHS COMPLIANT

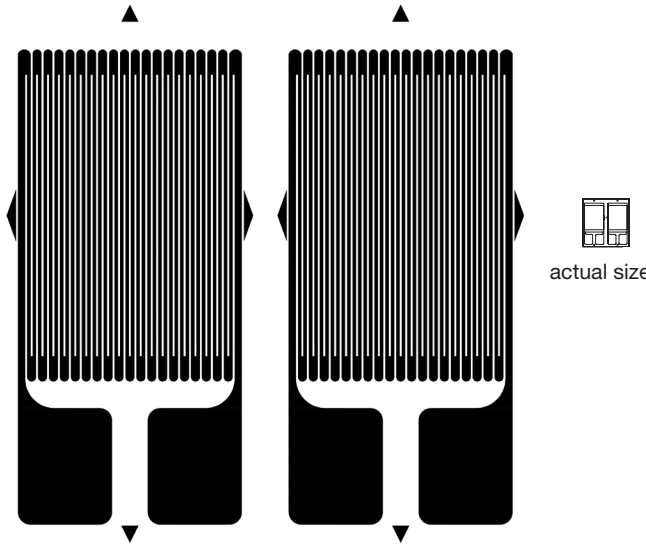

GAGE DIMENSIONS						inch	millimeter
Grid Length	Overall Length	Grid Width	Overall Width	Matrix Length	Matrix Width		
0.125	0.195	0.065	0.150	0.27	0.21		
3.18	4.96	1.65	3.81	6.9	5.3		

* Only creep code available for this gage.
Copper plating for tabs is available.

Transducer-Class® Strain Gages with Advanced Sensors Technology

S5119 GAGE PATTERN DATA			
 <p>actual size</p>	GAGE DESIGNATION	RESISTANCE IN OHMS	STD. CREEP CODE
	N2A-XX-S5119R-350/E4	350 ±0.2%	R
DESCRIPTION Dual-element gages widely used on bending-beam transducers.			

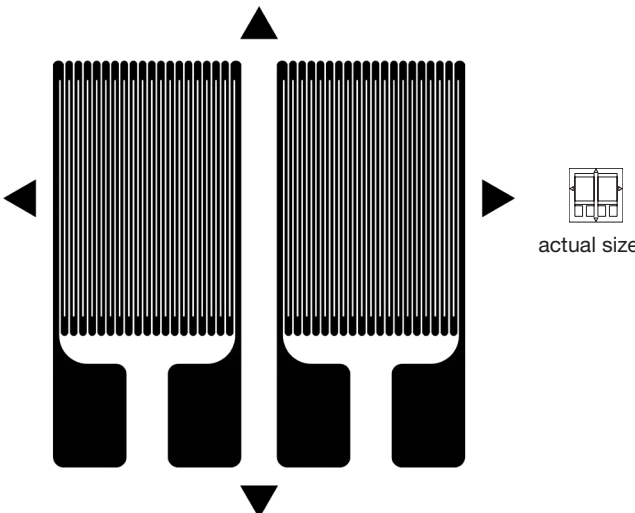

GAGE DIMENSIONS					
				inch	millimeter
Grid Length	Overall Length	Grid Width	Overall Width	Matrix Length	Matrix Width
0.126	0.224	0.100	0.221	0.25	0.24
3.20	5.68	2.54	5.61	6.3	6.1

S5167 GAGE PATTERN DATA			
 <p>actual size</p>	GAGE DESIGNATION	RESISTANCE IN OHMS	STD. CREEP CODE
	N2A-XX-S5167R-350/E4	350 ±0.2%	R*
DESCRIPTION Dual-element gages widely used on bending-beam transducers.			

GAGE DIMENSIONS					
				inch	millimeter
Grid Length	Overall Length	Grid Width	Overall Width	Matrix Length	Matrix Width
0.125	0.215	0.100	0.220	0.28	0.28
3.18	5.46	2.54	5.59	7.1	7.1

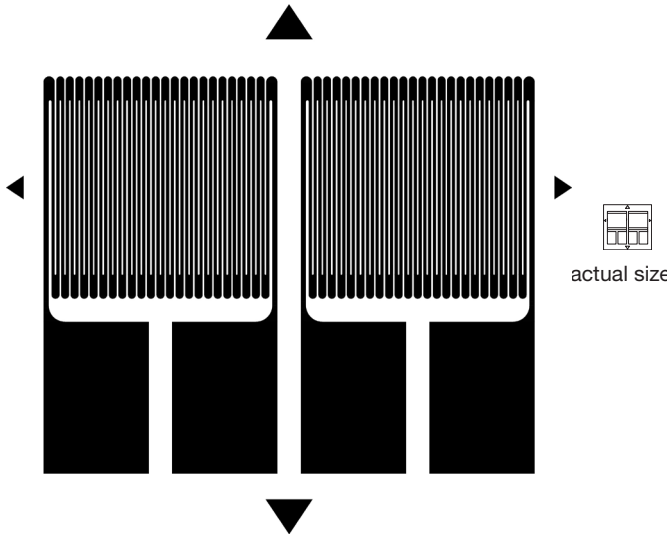

* Only creep code available for this gage.

Transducer-Class® Strain Gages with Advanced Sensors Technology

S5249 GAGE PATTERN DATA			
	GAGE DESIGNATION	RESISTANCE IN OHMS	STD. CREEP CODE
	N2K-XX-S5249R-10C/DG/E5 N5K-XX-S5249R-10C/DG/E5	1000 ±0.2% 1000 ±0.2%	R* R*
DESCRIPTION Small dual-element gage designed for bending-beam transducers.			

GAGE DIMENSIONS					
				inch	millimeter
Grid Length	Overall Length	Grid Width	Overall Width	Matrix Length	Matrix Width
0.075	0.170	0.100	0.210	0.24	0.25
1.90	4.31	2.54	5.33	6.0	6.4

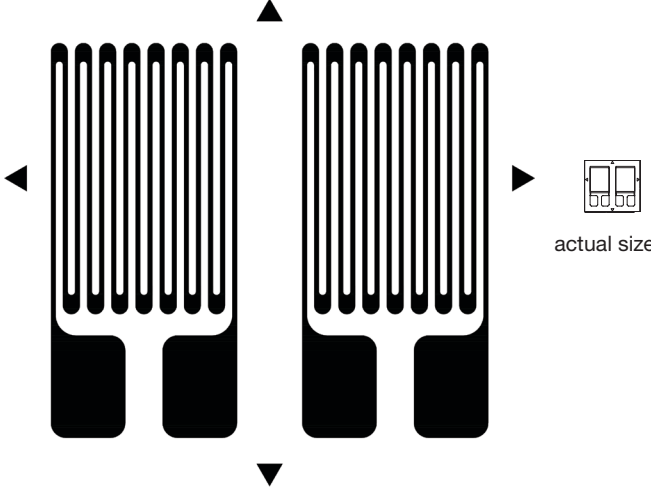

* Only creep code available for this gage.
Copper plating for tabs is available.

GAGE PATTERN DATA			
	GAGE DESIGNATION	RESISTANCE IN OHMS	STD. CREEP CODE
	N2A-XX-S5348R-700/E5 N2A-XX-S5258R-10C/E5	700 ±0.2% 1000 ±0.2%	R* R*
DESCRIPTION Dual-element gages widely used on bending-beam transducers.			

GAGE DIMENSIONS					
				inch	millimeter
Grid Length	Overall Length	Grid Width	Overall Width	Matrix Length	Matrix Width
0.125	0.212	0.100	0.235	0.27	0.29
3.18	5.39	2.54	5.99	6.9	7.4

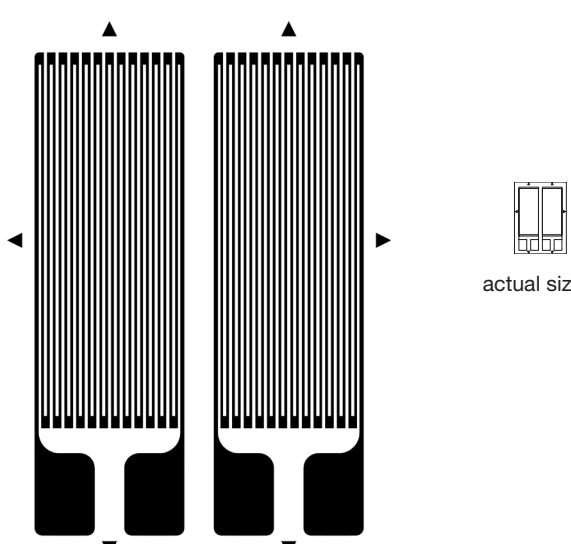

* Only creep code available for this gage.

Transducer-Class® Strain Gages with Advanced Sensors Technology

S5083 GAGE PATTERN DATA						
 <p>actual size</p>				GAGE DESIGNATION	RESISTANCE IN OHMS	STD. CREEP CODE
				N2K-XX-S5083P-10C/DG/E5 N5K-XX-S5083P-10C/DG/E5	1000 ±0.2% 1000 ±0.2%	P P
DESCRIPTION Widely used on bending-beam transducers where greater power dissipation is required.					 RoHS COMPLIANT	

GAGE DIMENSIONS						inch	millimeter
Grid Length	Overall Length	Grid Width	Overall Width	Matrix Length	Matrix Width		
0.236	0.324	0.100	0.220	0.37	0.27		
5.99	8.22	2.54	5.59	9.3	6.7		

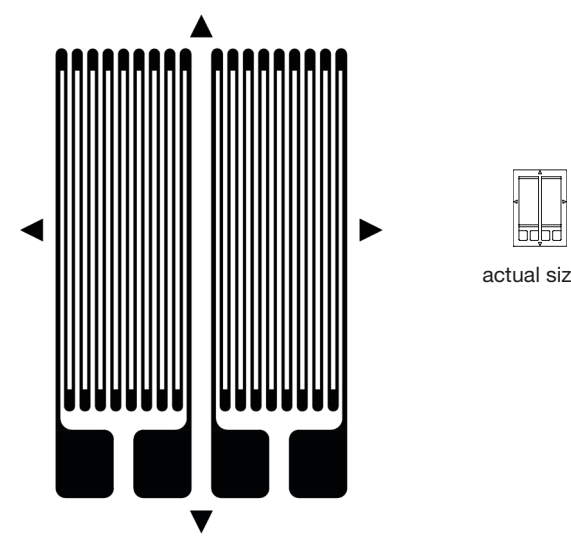

Copper plating for tabs is available.

S5277 GAGE PATTERN DATA						
 <p>actual size</p>				GAGE DESIGNATION	RESISTANCE IN OHMS	STD. CREEP CODE
				N2A-XX-S5277X-350/E5	350 ±0.2%	X*
DESCRIPTION Widely used on bending-beam transducers where greater power dissipation is required.					 RoHS COMPLIANT	

GAGE DIMENSIONS						inch	millimeter
Grid Length	Overall Length	Grid Width	Overall Width	Matrix Length	Matrix Width		
0.236	0.331	0.100	0.215	0.39	0.28		
5.99	8.40	2.54	5.47	9.9	7.0		

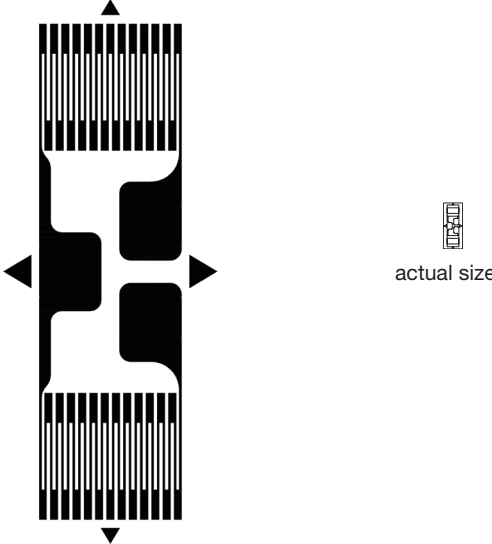

* Only creep code available for this gage.

Transducer-Class® Strain Gages with Advanced Sensors Technology

S5375 GAGE PATTERN DATA			
	GAGE DESIGNATION N2K-XX-S5375U-350/DG/E4 N5K-XX-S5375U-350/DG/E4	RESISTANCE IN OHMS 350 ±0.2% 350 ±0.2%	STD. CREEP CODE U* U*
	DESCRIPTION Half-bridge common-tab pattern. Grid centerline spacing 0.164 in (4.17 mm).		 RoHS COMPLIANT

GAGE DIMENSIONS					
				inch	millimeter
Grid Length	Overall Length	Grid Width	Overall Width	Matrix Length	Matrix Width
0.030	0.194	0.063	0.063	0.25	0.10
0.76	4.93	1.60	1.60	6.4	2.6

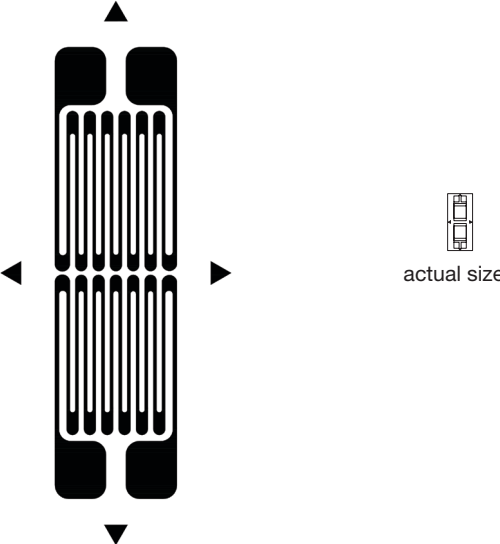

* Only creep code available for this gage.
Copper plating for tabs is available.

S5333 GAGE PATTERN DATA			
	GAGE DESIGNATION N2K-XX-S5333P-350/DG/E4 N5K-XX-S5333P-350/DG/E4	RESISTANCE IN OHMS 350 ±0.2% 350 ±0.2%	STD. CREEP CODE P* P*
	DESCRIPTION Dual-element pattern for narrow bending beams. Grid centerline spacing 0.080 in (2.03mm)		 RoHS COMPLIANT

GAGE DIMENSIONS					
				inch	millimeter
Grid Length	Overall Length	Grid Width	Overall Width	Matrix Length	Matrix Width
0.062	0.230	0.062	0.062	0.29	0.13
1.57	5.84	1.57	1.57	7.3	3.2

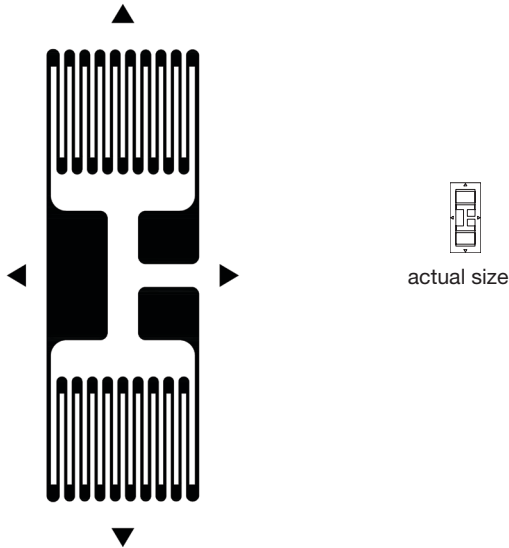

* Only creep code available for this gage.
Copper plating for tabs is available.

Transducer-Class® Strain Gages with Advanced Sensors Technology

S5266 GAGE PATTERN DATA					
 <p>actual size</p>	GAGE DESIGNATION	RESISTANCE IN OHMS	STD. CREEP CODE		
	N2A-XX-S5266R-350/E5	350 ±0.2%	R*		
DESCRIPTION					
Half-bridge common-tab pattern. Grid centerline spacing 0.215 in (5.46 mm).					

GAGE DIMENSIONS						inch	millimeter
Grid Length	Overall Length	Grid Width	Overall Width	Matrix Length	Matrix Width		
0.060	0.285	0.100	0.100	0.36	0.16		
1.52	7.24	2.54	2.54	9.3	4.1		

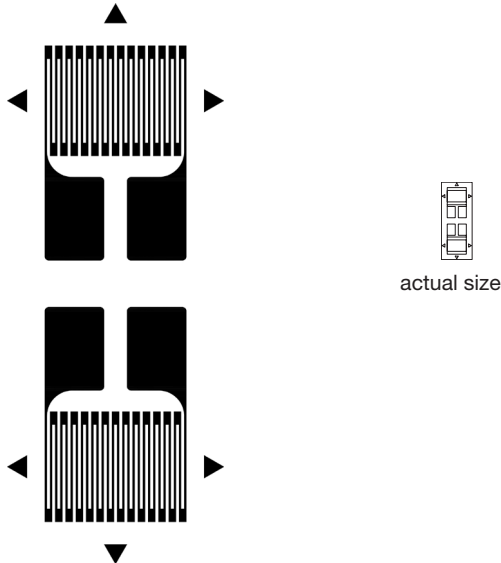

* Only creep code available for this gage.

S5269 GAGE PATTERN DATA					
 <p>actual size</p>	GAGE DESIGNATION	RESISTANCE IN OHMS	STD. CREEP CODE		
	N2K-XX-S5269Q-350/DG/E5 N5K-XX-S5269Q-350/DG/E5	350 ±0.2% 350 ±0.2%	Q* Q*		
DESCRIPTION					
Dual-element pattern for bending beams.					

GAGE DIMENSIONS						inch	millimeter
Grid Length	Overall Length	Grid Width	Overall Width	Matrix Length	Matrix Width		
0.060	0.328	0.100	0.100	0.41	0.16		
1.52	8.33	2.54	2.54	10.3	4.1		

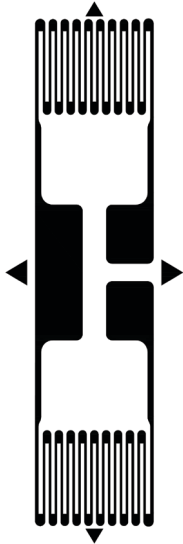

* Only creep code available for this gage.
Copper plating for tabs is available.

Transducer-Class® Strain Gages with Advanced Sensors Technology

S5297 GAGE PATTERN DATA			
 <p style="text-align: center;">actual size</p>	GAGE DESIGNATION	RESISTANCE IN OHMS	STD. CREEP CODE
	N2A-XX-S5297R-350/E5	350 ±0.2%	R*
DESCRIPTION Half-bridge common-tab pattern. Grid centerline spacing 0.350 in (8.89 mm).			

GAGE DIMENSIONS						inch		millimeter	
Grid Length	Overall Length	Grid Width	Overall Width	Matrix Length	Matrix Width				
0.060	0.420	0.100	0.100	0.47	0.16				
1.52	10.67	2.54	2.54	12.0	4.1				

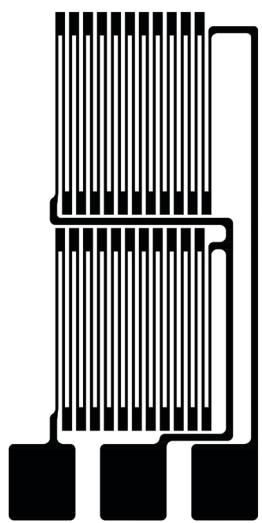

* Only creep code available for this gage.

S5070 GAGE PATTERN DATA			
 <p style="text-align: center;">actual size</p>	GAGE DESIGNATION	RESISTANCE IN OHMS	STD. CREEP CODE
	N2K-XX-S5070Q-20C/DG/E3 N5K-XX-S5070Q-20C/DG/E3	2000 ±0.2% 2000 ±0.2%	Q* Q*
DESCRIPTION Half-bridge common-tab pattern.			

GAGE DIMENSIONS						inch		millimeter	
Grid Length	Overall Length	Grid Width	Overall Width	Matrix Length	Matrix Width				
0.062	0.201	0.062	0.098	0.25	0.13				
1.58	5.11	1.58	2.49	6.3	3.2				

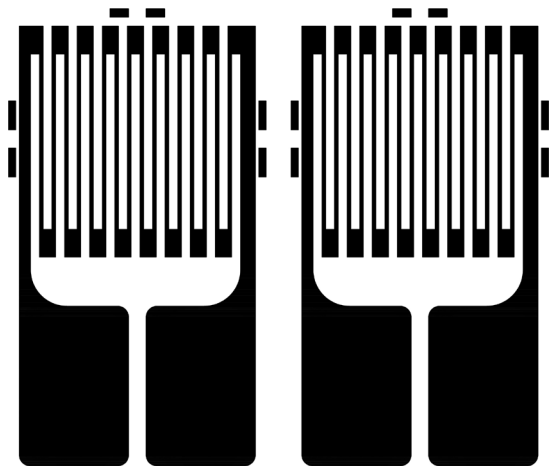

* Only creep code available for this gage.
Copper plating for tabs is available.

Transducer-Class® Strain Gages with Advanced Sensors Technology

S5280 GAGE PATTERN DATA			
 <p>actual size</p>	GAGE DESIGNATION	RESISTANCE IN OHMS	STD. CREEP CODE
	N2K-XX-S5280Q-50C/DG/E3 N5K-XX-S5280Q-50C/DG/E3	5000 ±0.2% 5000 ±0.2%	Q* Q*
DESCRIPTION			
Dual linear S5044 gage side by side.			

GAGE DIMENSIONS					
				inch	millimeter
Grid Length	Overall Length	Grid Width	Overall Width	Matrix Length	Matrix Width
0.050	0.129	0.065	0.065	0.14	0.15
1.27	3.27	1.65	1.65	3.6	3.9

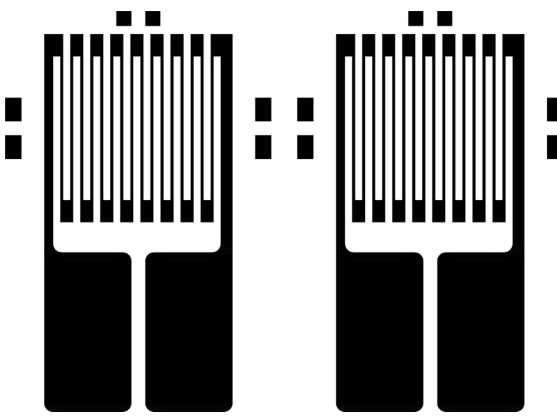

* Only creep code available for this gage.
Copper plating for tabs is available.

S5054 GAGE PATTERN DATA			
 <p>actual size</p>	GAGE DESIGNATION	RESISTANCE IN OHMS	STD. CREEP CODE
	N2K-XX-S5054K-50C/DG/E5 N5K-XX-S5054K-50C/DG/E5	5000 ±0.2% 5000 ±0.2%	K* K*
DESCRIPTION			
Small full bridge for bending-beam transducers. Bridge is balanced to ±0.4 mV/V, but RG is 1000 Ω ±3%.			

GAGE DIMENSIONS					
				inch	millimeter
Grid Length	Overall Length	Grid Width	Overall Width	Matrix Length	Matrix Width
0.050	0.129	0.065	0.166	0.17	0.20
1.27	3.27	1.65	4.22	4.2	5.1

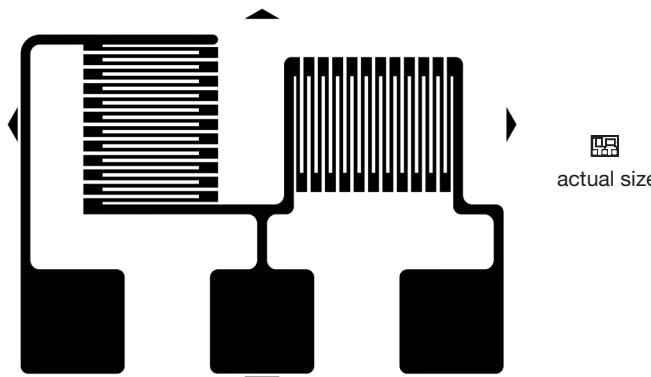

* Only creep code available for this gage.
Copper plating for tabs is available.

Transducer-Class® Strain Gages with Advanced Sensors Technology

GAGE PATTERN DATA			
	GAGE DESIGNATION	RESISTANCE IN OHMS	STD. CREEP CODE
	N2A-XX-S5209K-175/E5	175 ±0.2%	K*
	N2K-XX-S5038P-10C/DG/E5	1000 ±0.2%	P
	N5K-XX-S5038P-10C/DG/E5	1000 ±0.2%	P
	N2K-XX-S5039H-50C/DG/E3	5000 ±0.3%	H*
	N5K-XX-S5039H-50C/DG/E3	5000 ±0.3%	H*
DESCRIPTION Encapsulated 90° tee rosette.			 RoHS COMPLIANT

GAGE DIMENSIONS					
				inch	millimeter
Grid Length	Overall Length	Grid Width	Overall Width	Matrix Length	Matrix Width
0.033	0.092	0.051	0.130	0.10	0.14
0.83	2.34	1.30	3.30	2.7	3.6

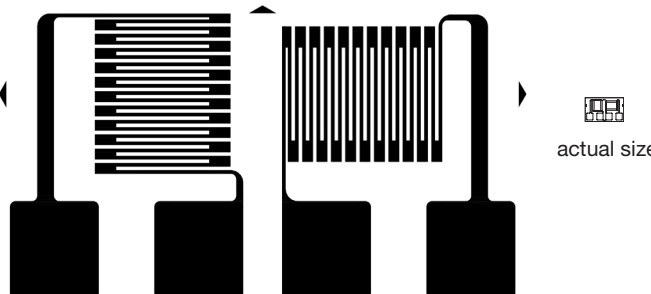

* Only creep code available for this gage.
Copper plating for tabs when applicable.

GAGE PATTERN DATA			
	GAGE DESIGNATION	RESISTANCE IN OHMS	STD. CREEP CODE
	N2K-XX-S5096Q-10C/DG/E3	1000 ±0.2%	Q*
	N5K-XX-S5096Q-10C/DG/E3	1000 ±0.2%	Q*
	N2K-XX-S5101M-50C/DG/E3	5000 ±0.2%	M*
	N5K-XX-S5101M-50C/DG/E3	5000 ±0.2%	M*
DESCRIPTION General-purpose 90° tee rosette.			 RoHS COMPLIANT

GAGE DIMENSIONS					
				inch	millimeter
Grid Length	Overall Length	Grid Width	Overall Width	Matrix Length	Matrix Width
0.034	0.102	0.055	0.182	0.12	0.20
0.85	2.59	1.41	4.62	3.1	5.0

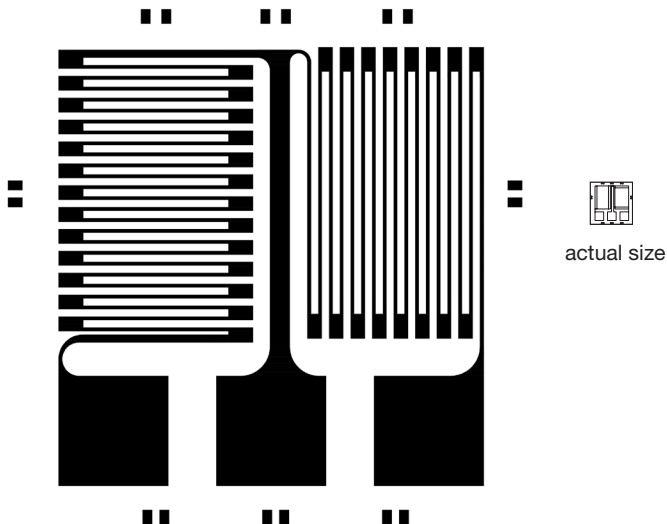

* Only creep code available for this gage.
Copper plating for tabs is available.

Transducer-Class® Strain Gages with Advanced Sensors Technology

GAGE PATTERN DATA			
 <p>actual size</p>	GAGE DESIGNATION N2A-XX-S5189R-175/E5 N2A-XX-S5161R-350/E5	RESISTANCE IN OHMS 175 ±0.2% 350 ±0.2%	STD. CREEP CODE R* R*
	DESCRIPTION Designed for half-bridge transducers.		 RoHS COMPLIANT

GAGE DIMENSIONS					
				inch	millimeter
Grid Length	Overall Length	Grid Width	Overall Width	Matrix Length	Matrix Width
0.100	0.175	0.120	0.175	0.22	0.22
2.54	4.44	3.00	4.44	5.6	5.6

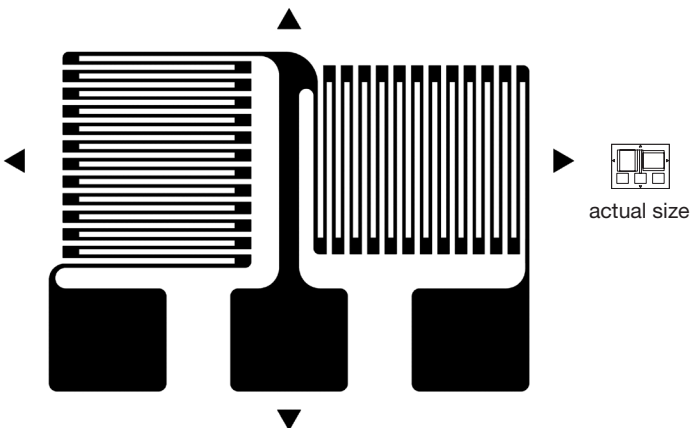

* Only creep code available for this gage.

GAGE PATTERN DATA			
 <p>actual size</p>	GAGE DESIGNATION N2A-XX-S5129N-350/E4 N2A-XX-S5152P-10C/E4	RESISTANCE IN OHMS 350 ±0.2% 1000 ±0.2%	STD. CREEP CODE N P
	DESCRIPTION General-purpose, three-tab 90° tee rosette.		 RoHS COMPLIANT

GAGE DIMENSIONS					
				inch	millimeter
Grid Length	Overall Length	Grid Width	Overall Width	Matrix Length	Matrix Width
0.080	0.165	0.110	0.246	0.23	0.30
2.03	4.20	2.79	6.25	5.8	7.6

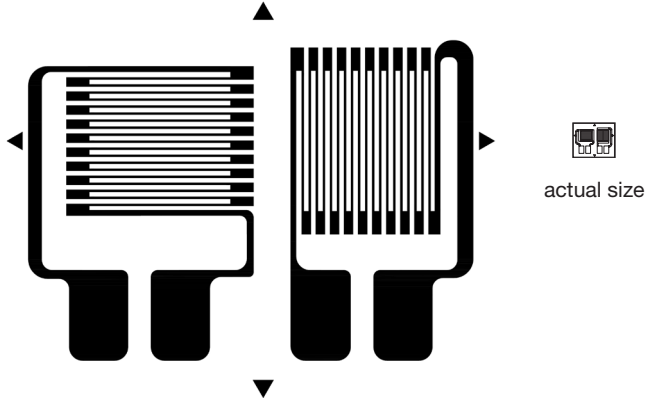

* Only creep code available for this gage.

Transducer-Class® Strain Gages with Advanced Sensors Technology

S5195 GAGE PATTERN DATA			
 <p>actual size</p>	GAGE DESIGNATION	RESISTANCE IN OHMS	STD. CREEP CODE
	N2A-XX-S5195R-350/E5	350 ±0.2%	R*
DESCRIPTION			 <p>RoHS COMPLIANT</p>
General-purpose, four-tab 90° tee rosette.			

GAGE DIMENSIONS						inch	millimeter
Grid Length	Overall Length	Grid Width	Overall Width	Matrix Length	Matrix Width		
0.062	0.137	0.062	0.160	0.18	0.22		
1.57	3.48	1.57	4.07	4.6	5.6		

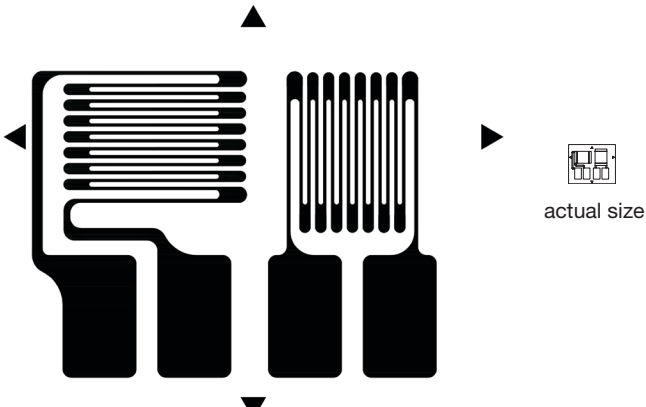

* Only creep code available for this gage.

S5190 GAGE PATTERN DATA			
 <p>actual size</p>	GAGE DESIGNATION	RESISTANCE IN OHMS	STD. CREEP CODE
	N2K-XX-S5190T-350/DP/E5 N5K-XX-S5190T-350/DP/E5	350 ±0.2% 350 ±0.2%	T* T*
DESCRIPTION			 <p>RoHS COMPLIANT</p>
General-purpose, four-tab 90° tee rosette.			

GAGE DIMENSIONS						inch	millimeter
Grid Length	Overall Length	Grid Width	Overall Width	Matrix Length	Matrix Width		
0.062	0.157	0.062	0.178	0.20	0.25		
1.57	3.98	1.57	4.51	5.2	6.2		

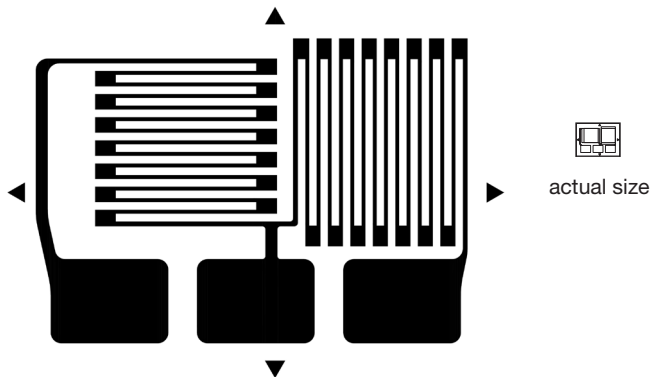

* Only creep code available for this gage.
Copper plating for tabs is available.

Transducer-Class® Strain Gages with Advanced Sensors Technology

S5115 GAGE PATTERN DATA			
 <p>actual size</p>	GAGE DESIGNATION	RESISTANCE IN OHMS	STD. CREEP CODE
	N2K-XX-S5115T-350/DG/E3 N5K-XX-S5115T-350/DG/E3	350 ±0.2% 350 ±0.2%	T* T*
DESCRIPTION General-purpose, three-tab 90° tee rosette.			 RoHS COMPLIANT

GAGE DIMENSIONS					
				inch	millimeter
Grid Length	Overall Length	Grid Width	Overall Width	Matrix Length	Matrix Width
0.100	0.245	0.100	0.170	0.31	0.23
2.54	6.22	2.54	4.32	7.7	5.8

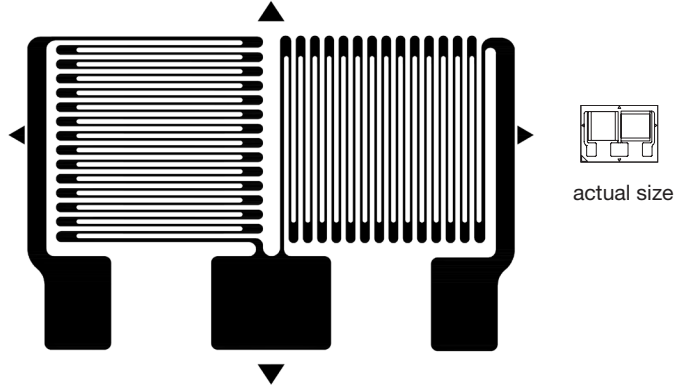

* Only creep code available for this gage.
Copper plating for tabs is available.

S5255 GAGE PATTERN DATA			
 <p>actual size</p>	GAGE DESIGNATION	RESISTANCE IN OHMS	STD. CREEP CODE
	N2A-XX-S5255W-350/E5	350 ±0.2%	W*
DESCRIPTION General-purpose, three-tab 90° tee rosette.			 RoHS COMPLIANT

GAGE DIMENSIONS					
				inch	millimeter
Grid Length	Overall Length	Grid Width	Overall Width	Matrix Length	Matrix Width
0.125	0.235	0.150	0.340	0.30	0.40
3.18	5.97	3.81	8.64	7.5	10.2

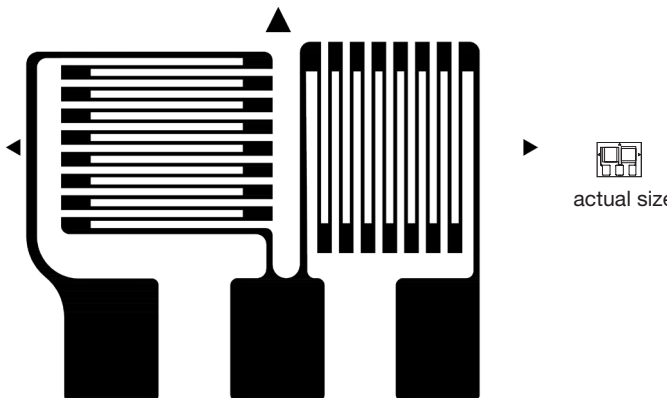

* Only creep code available for this gage.

Transducer-Class® Strain Gages with Advanced Sensors Technology

S5284 GAGE PATTERN DATA			
 <p>actual size</p>	GAGE DESIGNATION	RESISTANCE IN OHMS	STD. CREEP CODE
	N2A-XX-S5284T-10C/E5	1000 ±0.2%	T*
DESCRIPTION			 RoHS COMPLIANT
General-purpose, three-tab 90° tee rosette.			

GAGE DIMENSIONS						inch	millimeter
Grid Length	Overall Length	Grid Width	Overall Width	Matrix Length	Matrix Width		
0.063	0.149	0.075	0.182	0.18	0.23		
1.60	3.78	1.91	4.62	4.5	5.8		

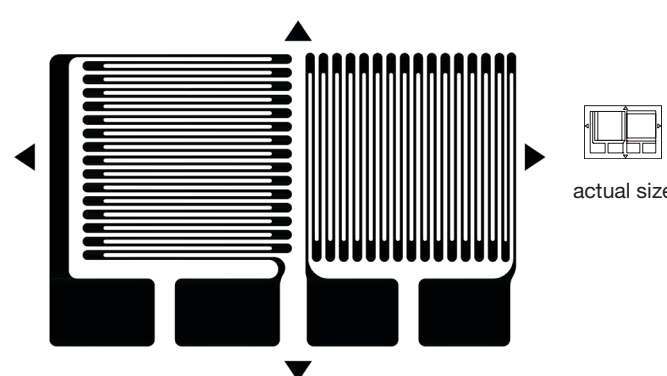

* Only creep code available for this gage.

S5302 GAGE PATTERN DATA			
 <p>actual size</p>	GAGE DESIGNATION	RESISTANCE IN OHMS	STD. CREEP CODE
	N2A-XX-S5302W-350/E5 N2A-XX-S5302W-350/E5	350 ±0.2% 350 ±0.2%	W* W*
DESCRIPTION			 RoHS COMPLIANT
General-purpose, four-tab 90° tee rosette.			

GAGE DIMENSIONS						inch	millimeter
Grid Length	Overall Length	Grid Width	Overall Width	Matrix Length	Matrix Width		
0.125	0.218	0.150	0.340	0.28	0.40		
3.18	5.53	3.81	8.64	7.00	10.2		

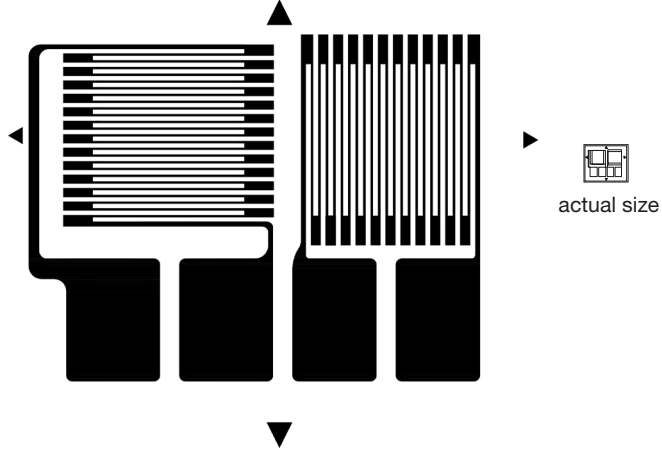

* Only creep code available for this gage.

Transducer-Class® Strain Gages with Advanced Sensors Technology

S5194 GAGE PATTERN DATA			
	GAGE DESIGNATION	RESISTANCE IN OHMS	STD. CREEP CODE
	N2A-XX-S5194T-10C/E5	1000 ±0.2%	T*
DESCRIPTION General-purpose, four-tab 90° tee rosette.			 RoHS COMPLIANT

GAGE DIMENSIONS					
				inch	millimeter
Grid Length	Overall Length	Grid Width	Overall Width	Matrix Length	Matrix Width
0.063	0.142	0.075	0.182	0.19	0.23
1.60	3.60	1.91	4.62	4.9	5.8

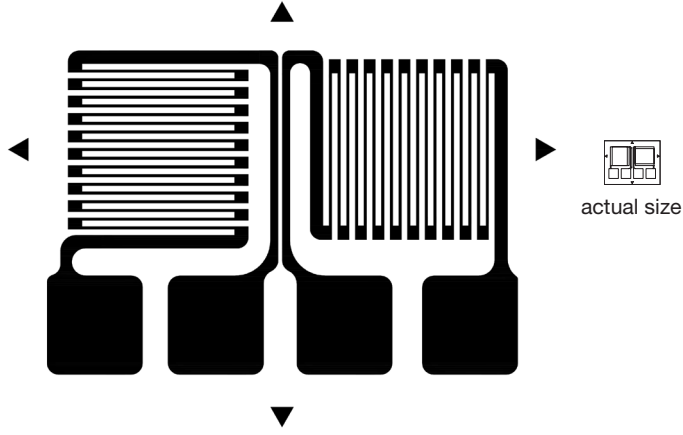

* Only creep code available for this gage.

S5226 GAGE PATTERN DATA			
	GAGE DESIGNATION	RESISTANCE IN OHMS	STD. CREEP CODE
	N2A-XX-S5226M-10C/E5	1000 ±0.2%	M*
DESCRIPTION General-purpose, four-tab 90° tee rosette.			 RoHS COMPLIANT

GAGE DIMENSIONS					
				inch	millimeter
Grid Length	Overall Length	Grid Width	Overall Width	Matrix Length	Matrix Width
0.079	0.165	0.098	0.243	0.23	0.29
2.01	4.20	2.50	6.18	5.8	7.4

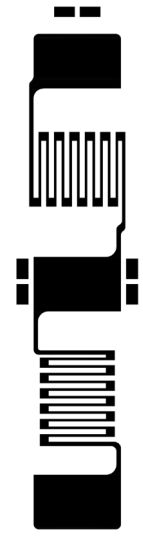

* Only creep code available for this gage.

Transducer-Class® Strain Gages with Advanced Sensors Technology

S5045 GAGE PATTERN DATA			
 <p style="text-align: center;">actual size</p>	GAGE DESIGNATION N2K-XX-S5045H-10C/DG/E5 N5K-XX-S5045H-10C/DG/E5	RESISTANCE IN OHMS 1000 ±0.2% 1000 ±0.2%	STD. CREEP CODE H* H*
	DESCRIPTION Often used on small column transducers.		 RoHS COMPLIANT

GAGE DIMENSIONS						inch	millimeter
Grid Length	Overall Length	Grid Width	Overall Width	Matrix Length	Matrix Width		
0.033	0.291	0.056	0.056	0.33	0.08		
0.80	7.40	1.40	1.40	8.4	2.0		

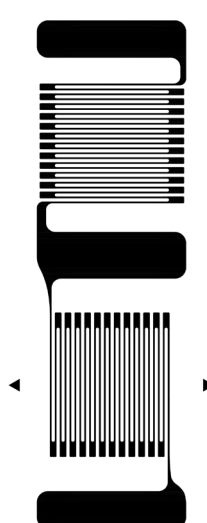

* Only creep code available for this gage.
Copper plating for tabs is available.

S5204 GAGE PATTERN DATA			
 <p style="text-align: center;">actual size</p>	GAGE DESIGNATION N2A-XX-S5204Q-350/E5	RESISTANCE IN OHMS 350 ±0.2%	STD. CREEP CODE Q*
	DESCRIPTION Often used on column transducers.		 RoHS COMPLIANT

GAGE DIMENSIONS						inch	millimeter
Grid Length	Overall Length	Grid Width	Overall Width	Matrix Length	Matrix Width		
0.062	0.272	0.062	0.080	0.31	0.12		
1.57	6.92	1.57	2.03	7.9	3.0		

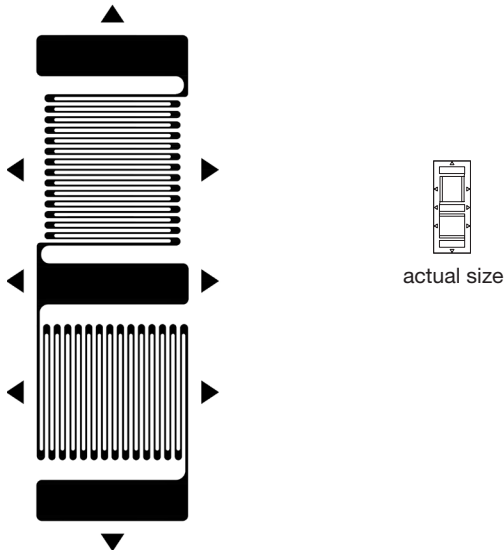

* Only creep code available for this gage.

Transducer-Class® Strain Gages with Advanced Sensors Technology

S5248 GAGE PATTERN DATA			
 <p>actual size</p>	GAGE DESIGNATION	RESISTANCE IN OHMS	STD. CREEP CODE
	N2A-XX-S5248P-350/E5	350 ±0.2%	P*
DESCRIPTION Often used on column transducers.			 <p>Pb-free RoHS COMPLIANT</p>

GAGE DIMENSIONS					
				inch	millimeter
Grid Length	Overall Length	Grid Width	Overall Width	Matrix Length	Matrix Width
0.100	0.415	0.130	0.130	0.48	0.19
2.54	10.54	3.30	3.30	12.1	4.8

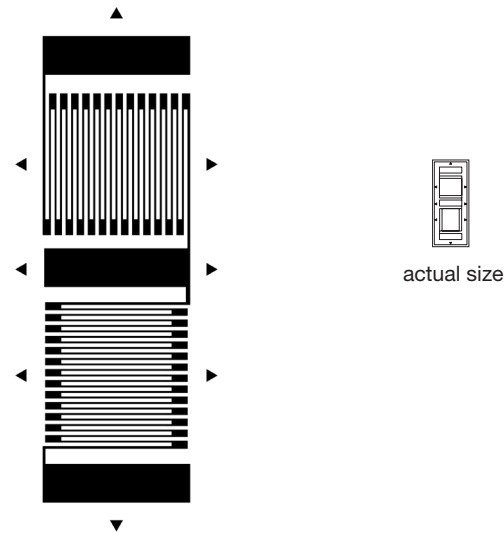

* Only creep code available for this gage.

S5086 GAGE PATTERN DATA			
 <p>actual size</p>	GAGE DESIGNATION	RESISTANCE IN OHMS	STD. CREEP CODE
	N2K-XX-S5086V-10C/DG/E5 N5K-XX-S5086V-10C/DG/E5	1000 ±0.2% 1000 ±0.2%	V* V*
DESCRIPTION Often used on column transducers.			 <p>Pb-free RoHS COMPLIANT</p>

GAGE DIMENSIONS					
Grid Length	Overall Length	Grid Width	Overall Width	Matrix Length	Matrix Width
0.100	0.415	0.130	0.130	0.48	0.19
2.54	10.54	3.30	3.30	12.1	4.8

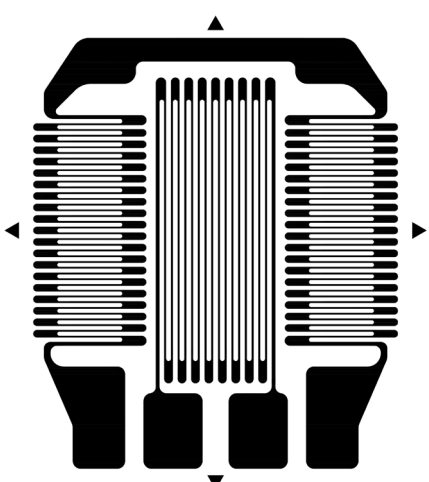

* Only creep code available for this gage.
Copper plating for tabs is available.

Transducer-Class® Strain Gages with Advanced Sensors Technology

S5257 GAGE PATTERN DATA			
  actual size	GAGE DESIGNATION	RESISTANCE IN OHMS	STD. CREEP CODE
	N2A-XX-S5257Y-350/E5	350 ±0.2%	Y*
DESCRIPTION Used on high-accuracy column load cells. (1) Gage length is 0.200 in (5.1 mm). (2) Transverse gage length is 0.050 in (1.27 mm).			 RoHS COMPLIANT

GAGE DIMENSIONS					
				inch	millimeter
Grid Length	Overall Length	Grid Width	Overall Width	Matrix Length	Matrix Width
(1)	0.294	(2)	0.242	0.37	0.33
(1)	7.48	(2)	6.14	9.4	8.4

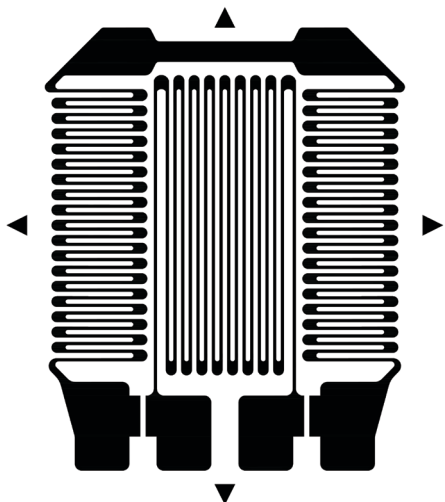

* Only creep code available for this gage.

GAGE PATTERN DATA			
  actual size	GAGE DESIGNATION	RESISTANCE IN OHMS	STD. CREEP CODE
	N2A-XX-S5345R-700/E5 N2A-XX-S5346T-10C/E5	700 ±0.2% 1000 ±0.2%	R* T*
DESCRIPTION Used on high-accuracy column load cells. (1) Gage length is 0.200 in (5.1 mm). (2) Transverse gage length is 0.050 in (1.27mm).			 RoHS COMPLIANT

GAGE DIMENSIONS					
				inch	millimeter
Grid Length	Overall Length	Grid Width	Overall Width	Matrix Length	Matrix Width
(1)	0.325	(2)	0.240	0.38	0.33
(1)	8.25	(2)	6.10	9.5	8.4

* Only creep code available for this gage.

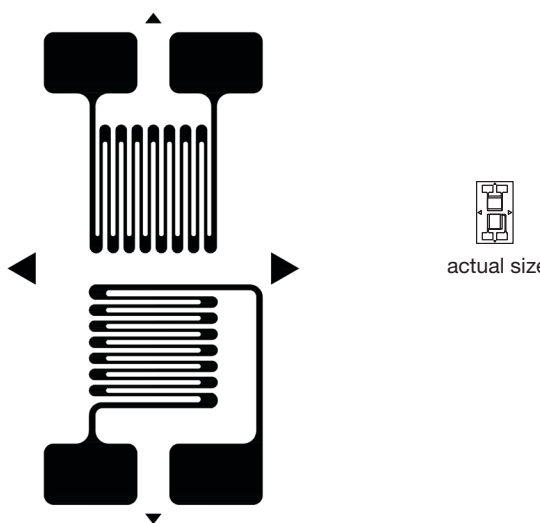

Transducer-Class® Strain Gages with Advanced Sensors Technology

S5376 GAGE PATTERN DATA			
 <p>actual size</p>	GAGE DESIGNATION	RESISTANCE IN OHMS	STD. CREEP CODE
	N2A-XX-S5376H-350/E3	350 ±0.2%	H*
DESCRIPTION Miniature 90° tee rosette with tabs on opposite sides			

GAGE DIMENSIONS					
				inch	millimeter
Grid Length	Overall Length	Grid Width	Overall Width	Matrix Length	Matrix Width
0.030	0.147	0.040	0.067	0.17	0.10
0.75	3.74	1.00	1.72	4.3	2.5

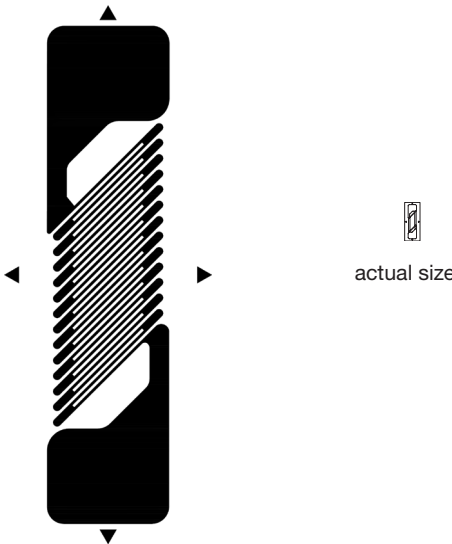

* Only creep code available for this gage.

Transducer-Class® Strain Gages with Advanced Sensors Technology

GAGE PATTERN DATA			
	GAGE DESIGNATION	RESISTANCE IN OHMS	STD. CREEP CODE
	N2K-XX-S5218Q-350/DG/E5 N5K-XX-S5218Q-350/DG/E5 N2K-XX-S5033Q-10C/DG/E5 N5K-XX-S5033Q-10C/DG/E5 N2K-XX-S5034Q-50C/DG/E5 N5K-XX-S5034Q-50C/DG/E5	350 ±0.2% 350 ±0.2% 1000 ±0.2% 1000 ±0.2% 5000 ±0.2% 5000 ±0.2%	Q* Q* Q Q Q Q
DESCRIPTION Single-element miniature shear pattern.			 RoHS COMPLIANT

GAGE DIMENSIONS					
				inch	millimeter
Grid Length	Overall Length	Grid Width	Overall Width	Matrix Length	Matrix Width
0.034	0.173	0.050	0.042	0.19	0.08
0.86	4.39	1.27	1.07	4.9	2.0

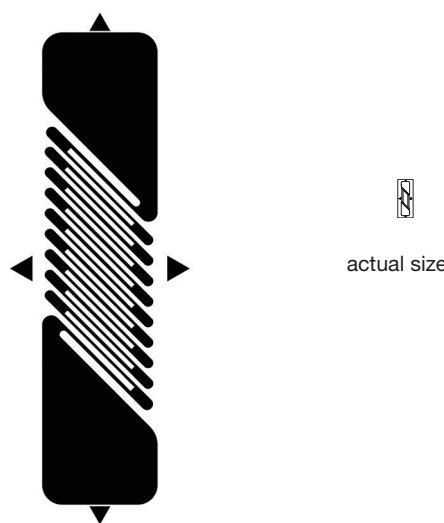

* Only creep code available for this gage.
Copper plating for tabs is available.

S5276 GAGE PATTERN DATA			
	GAGE DESIGNATION	RESISTANCE IN OHMS	STD. CREEP CODE
	N2K-XX-S5276Q-10C/DG/E5 N5K-XX-S5276Q-10C/DG/E5	1000 ±0.2% 1000 ±0.2%	Q* Q*
DESCRIPTION Right-hand version of S5033.			 RoHS COMPLIANT

GAGE DIMENSIONS					
				inch	millimeter
Grid Length	Overall Length	Grid Width	Overall Width	Matrix Length	Matrix Width
0.034	0.173	0.050	0.042	0.19	0.08
0.85	4.39	1.27	1.07	4.9	2.0

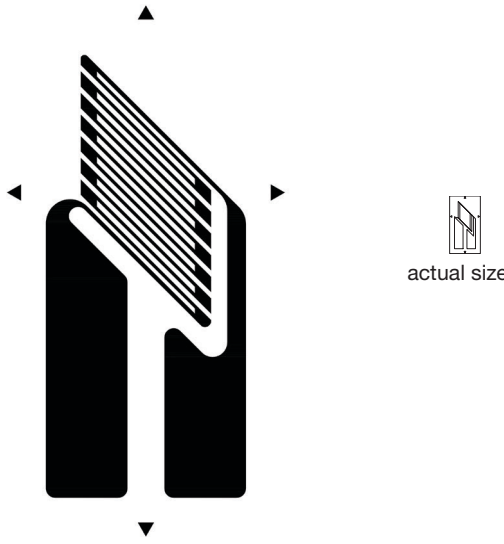

* Only creep code available for this gage.
Copper plating for tabs is available.

Transducer-Class® Strain Gages with Advanced Sensors Technology

GAGE PATTERN DATA			
	GAGE DESIGNATION	RESISTANCE IN OHMS	STD. CREEP CODE
	N2K-XX-S5125T-350/DG/E3 N5K-XX-S5125T-350/DG/E3 N2K-XX-S5102T-10C/DG/E3 N5K-XX-S5102T-10C/DG/E3	350 ±0.2% 350 ±0.2% 1000 ±0.2% 1000 ±0.2%	T* T* T* T*
DESCRIPTION Single-element shear pattern with tabs on one end.			 RoHS COMPLIANT

GAGE DIMENSIONS					
				inch	millimeter
Grid Length	Overall Length	Grid Width	Overall Width	Matrix Length	Matrix Width
0.075	0.255	0.060	0.108	0.30	0.16
1.90	6.48	1.52	2.74	7.5	4.0

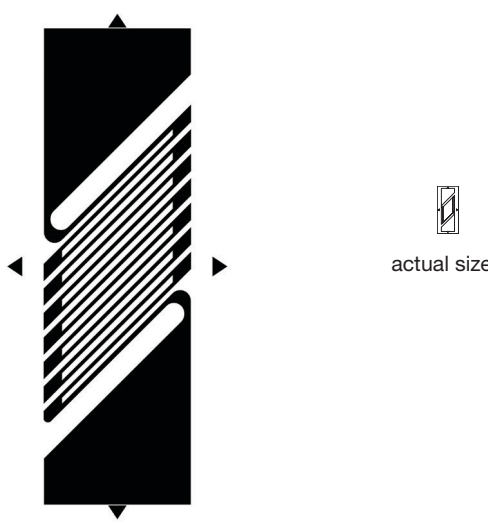

* Only creep code available for this gage.
Copper plating for tabs is available.

S5282 GAGE PATTERN DATA			
	GAGE DESIGNATION	RESISTANCE IN OHMS	STD. CREEP CODE
	N2K-XX-S5282T-350/DG/E4 N5K-XX-S5282T-350/DG/E4	350 ±0.2% 350 ±0.2%	T* T*
DESCRIPTION Single-element shear pattern.			 RoHS COMPLIANT

GAGE DIMENSIONS					
				inch	millimeter
Grid Length	Overall Length	Grid Width	Overall Width	Matrix Length	Matrix Width
0.075	0.240	0.059	0.070	0.25	0.11
1.91	6.14	1.50	1.78	6.4	2.9

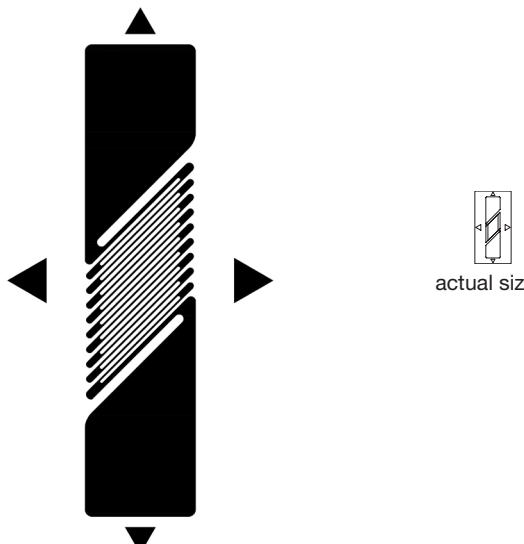

* Only creep code available for this gage.
Copper plating for tabs is available.

Transducer-Class® Strain Gages with Advanced Sensors Technology

S5358 GAGE PATTERN DATA			
 <p>actual size</p>	GAGE DESIGNATION	RESISTANCE IN OHMS	STD. CREEP CODE
	N2A-XX-S5358T-350/E4	350 ±0.2%	T*
DESCRIPTION			
Single-element shear pattern.			

GAGE DIMENSIONS					
				inch	millimeter
Grid Length	Overall Length	Grid Width	Overall Width	Matrix Length	Matrix Width
0.075	0.320	0.060	0.075	0.38	0.19
1.91	8.13	1.52	1.91	9.6	4.8

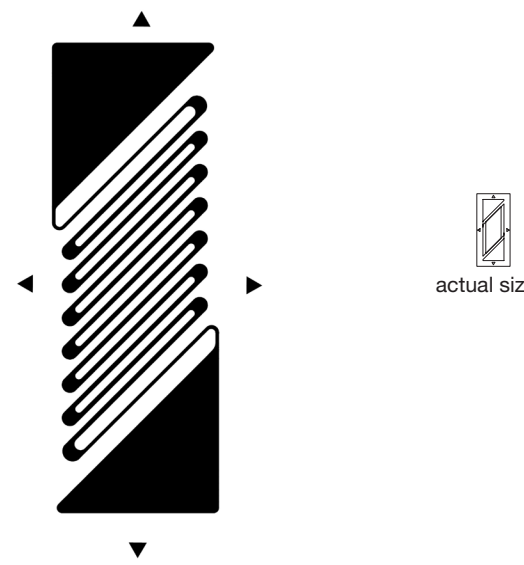

* Only creep code available for this gage.

S5183 GAGE PATTERN DATA			
 <p>actual size</p>	GAGE DESIGNATION	RESISTANCE IN OHMS	STD. CREEP CODE
	N2K-XX-S5183U-175/DG/E4 N5K-XX-S5183U-175/DG/E4	175 ±0.15% 175 ±0.15%	U* U*
DESCRIPTION			
Single-element shear pattern.			

GAGE DIMENSIONS					
				inch	millimeter
Grid Length	Overall Length	Grid Width	Overall Width	Matrix Length	Matrix Width
0.113	0.320	0.116	0.110	0.38	0.17
2.87	8.12	2.95	2.79	9.7	4.4

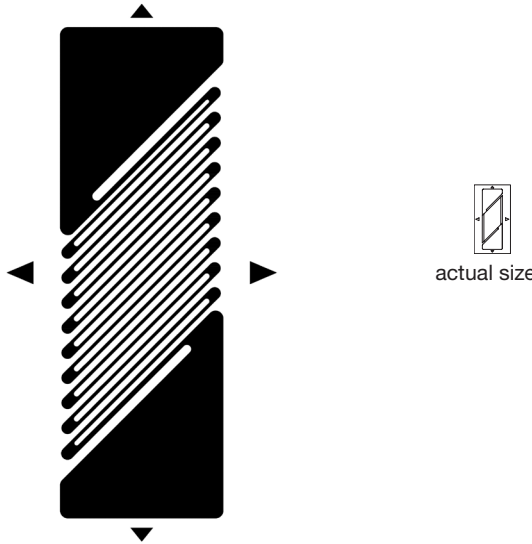

Copper plating for tabs is available.

Transducer-Class® Strain Gages with Advanced Sensors Technology

S5303 GAGE PATTERN DATA			
	GAGE DESIGNATION	RESISTANCE IN OHMS	STD. CREEP CODE
	N2A-XX-S5303R-350/E5	350 ±0.2%	R*
DESCRIPTION			 RoHS COMPLIANT
Single-element shear pattern.			

GAGE DIMENSIONS						inch	millimeter
Grid Length	Overall Length	Grid Width	Overall Width	Matrix Length	Matrix Width		
0.125	0.316	0.102	0.105	0.36	0.19		
3.17	8.02	2.59	2.66	9.1	4.8		

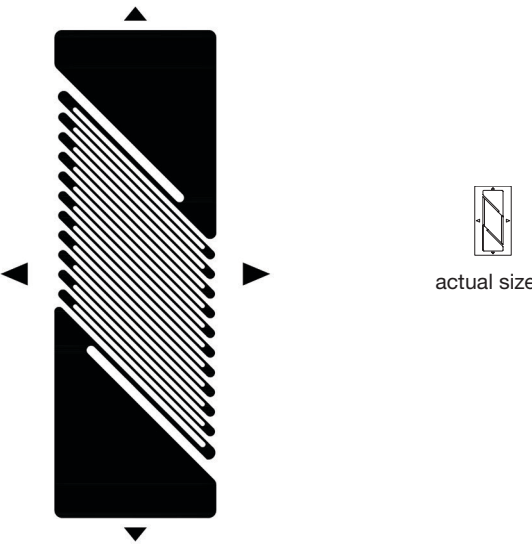

* Only creep code available for this gage.

S5306 GAGE PATTERN DATA			
	GAGE DESIGNATION	RESISTANCE IN OHMS	STD. CREEP CODE
	N2A-XX-S5306X-350/E5	350 ±0.2%	X*
DESCRIPTION			 RoHS COMPLIANT
Right-hand version of S5303.			

GAGE DIMENSIONS						inch	millimeter
Grid Length	Overall Length	Grid Width	Overall Width	Matrix Length	Matrix Width		
0.125	0.316	0.100	0.105	0.36	0.19		
3.17	8.02	2.54	2.66	9.1	4.8		

* Only creep code available for this gage.

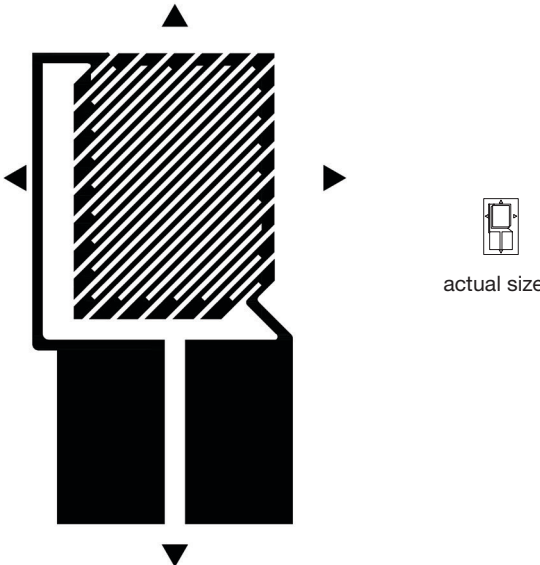

Transducer-Class® Strain Gages with Advanced Sensors Technology

S5061 GAGE PATTERN DATA			
 <p>actual size</p>	GAGE DESIGNATION	RESISTANCE IN OHMS	STD. CREEP CODE
	N2K-XX-S5061Q-50C/DP/E5 N5K-XX-S5061Q-50C/DP/E5	5000 ±0.2% 5000 ±0.2%	Q* Q*
DESCRIPTION High-resistance single-element shear pattern with tabs on one side.			 <p>RoHS COMPLIANT</p>

GAGE DIMENSIONS					
				inch	millimeter
Grid Length	Overall Length	Grid Width	Overall Width	Matrix Length	Matrix Width
0.120	0.232	0.136	0.115	0.28	0.18
3.05	5.89	3.45	2.92	7.2	4.4

* Only creep code available for this gage.
Copper plating for tabs is available.

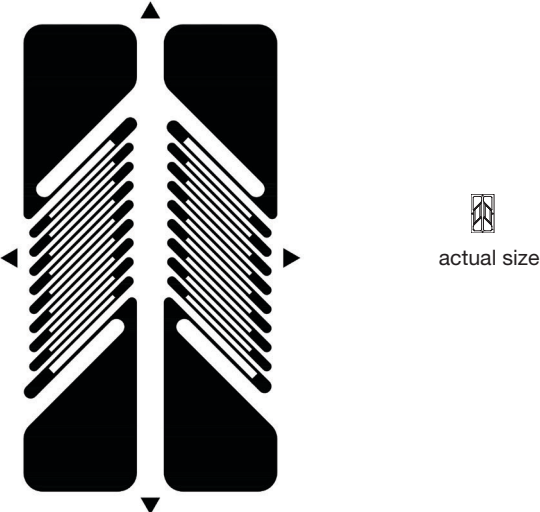
Transducer-Class® Strain Gages with Advanced Sensors Technology

GAGE PATTERN DATA			
	GAGE DESIGNATION	RESISTANCE IN OHMS	STD. CREEP CODE
	N2K-XX-S5136Q-175/DG/E4	175 ±0.2%	Q*
	N5K-XX-S5136Q-175/DG/E4	175 ±0.2%	Q*
	N2K-XX-S5130Q-350/DG/E4	350 ±0.2%	Q*
	N5K-XX-S5130Q-350/DG/E4	350 ±0.2%	Q*
	N2K-XX-S5278Q-500/DG/E5	500 ±0.2%	Q*
	N5K-XX-S5278Q-500/DG/E5	500 ±0.2%	Q*
	N2K-XX-S5064Q-10C/DG/E5	1000 ±0.2%	Q*
	N5K-XX-S5064Q-10C/DG/E5	1000 ±0.2%	Q*
DESCRIPTION Dual-element pattern for shear or torque transducers.			



GAGE DIMENSIONS					
				inch	millimeter
Grid Length	Overall Length	Grid Width	Overall Width	Matrix Length	Matrix Width
0.034	0.160	0.050	0.094	0.19	0.12
0.86	4.06	1.27	2.38	4.9	2.9

* Only creep code available for this gage.

*** For S5136, matrix length is 0.22 in (5.6 mm)

** Overall Length dimensions may differ from pattern to pattern.

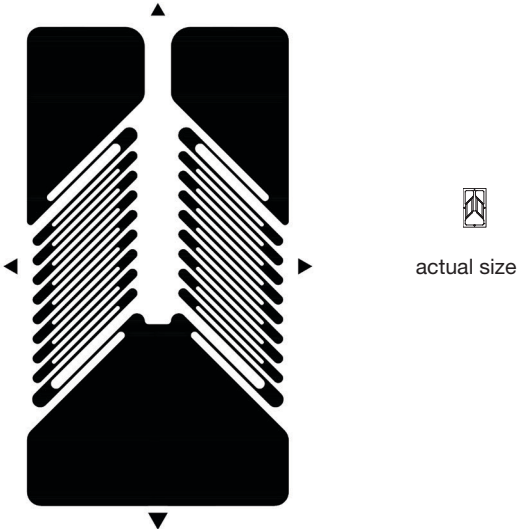

Copper plating for tabs is available.

S5208 GAGE PATTERN DATA			
	GAGE DESIGNATION	RESISTANCE IN OHMS	STD. CREEP CODE
	N2K-XX-S5208Q-350/DG/E5	350 ±0.2%	Q*
	N5K-XX-S5208Q-350/DG/E5	350 ±0.2%	Q*
DESCRIPTION Dual-element pattern for shear or torque transducers			

GAGE DIMENSIONS					
				inch	millimeter
Grid Length	Overall Length	Grid Width	Overall Width	Matrix Length	Matrix Width
0.034	0.173	0.050	0.094	0.20	0.12
0.85	4.39	1.27	2.39	5.0	3.0

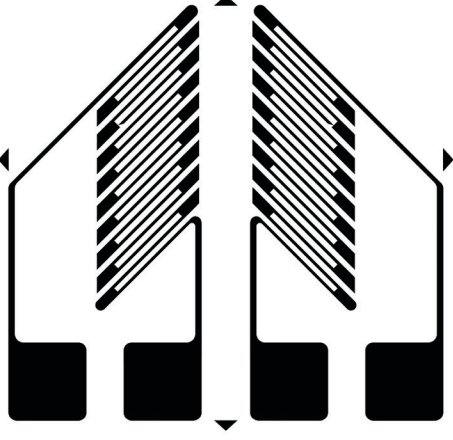

* Only creep code available for this gage.
Copper plating for tabs is available.

Transducer-Class[®] Strain Gages with Advanced Sensors Technology

GAGE PATTERN DATA			
 <p>actual size</p>	GAGE DESIGNATION	RESISTANCE IN OHMS	STD. CREEP CODE
	N2K-XX-S5035Q-10C/DG/E5 N5K-XX-S5035Q-10C/DG/E5 N2K-XX-S5036Q-50C/DG/E3 N5K-XX-S5036Q-50C/DG/E3	1000 ±0.2% 1000 ±0.2% 5000 ±0.2% 5000 ±0.2%	Q Q Q* Q*
DESCRIPTION Dual-element pattern for shear or torque transducers.			 RoHS COMPLIANT

GAGE DIMENSIONS					
				inch	millimeter
Grid Length	Overall Length	Grid Width	Overall Width	Matrix Length	Matrix Width
0.033	0.148	0.051	0.155	0.16	0.17
0.84	3.76	1.29	3.94	4.1	4.3

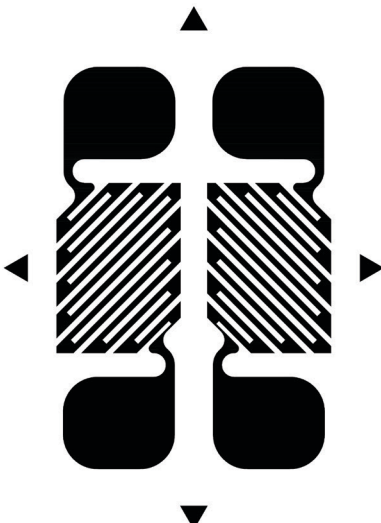

* Only creep code available for this gage.
Copper plating for tabs is available.

S5135 GAGE PATTERN DATA			
 <p>actual size</p>	GAGE DESIGNATION	RESISTANCE IN OHMS	STD. CREEP CODE
	N2A-XX-S5135M-350/E4	350 ±0.2%	M*
DESCRIPTION Dual-element pattern for shear or torque transducers.			 RoHS COMPLIANT

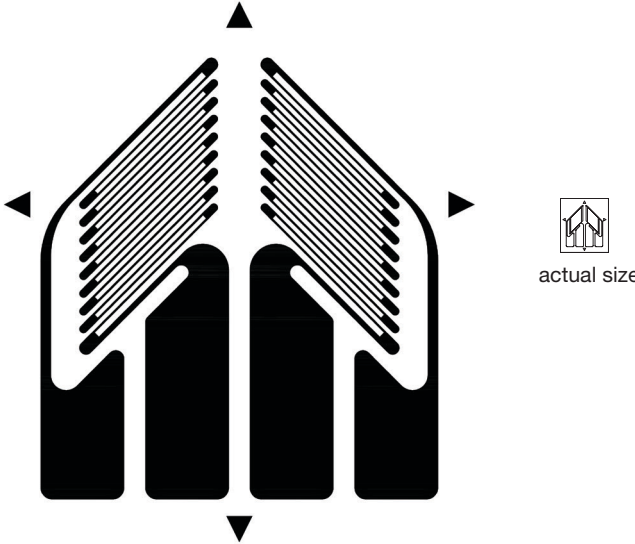

GAGE DIMENSIONS					
				inch	millimeter
Grid Length	Overall Length	Grid Width	Overall Width	Matrix Length	Matrix Width
0.064	0.175	0.070	0.113	0.23	0.17
1.62	4.44	1.77	2.87	6.0	4.4

* Only creep code available for this gage.

Transducer-Class® Strain Gages with Advanced Sensors Technology

S5095 GAGE PATTERN DATA			
	GAGE DESIGNATION	RESISTANCE IN OHMS	STD. CREEP CODE
	N2A-XX-S5095N-350/E5	350 ±0.2%	N
DESCRIPTION Dual-element pattern for shear or torque transducers.			

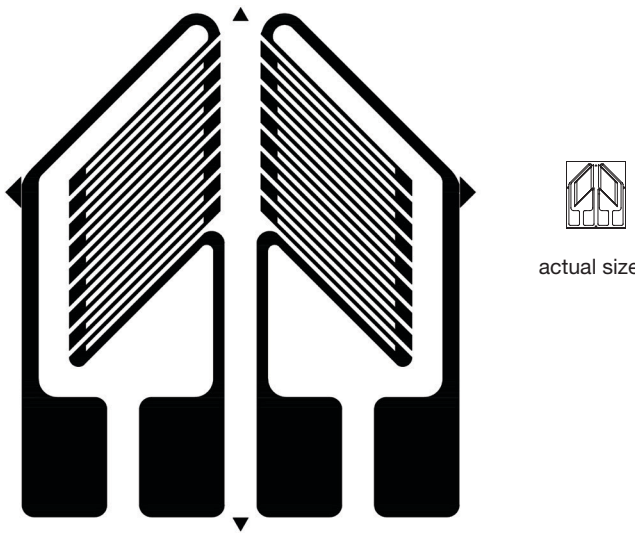

GAGE DIMENSIONS					
				inch	millimeter
Grid Length	Overall Length	Grid Width	Overall Width	Matrix Length	Matrix Width
0.079	0.215	0.056	0.190	0.28	0.25
2.01	5.46	1.43	4.83	7.2	6.4

GAGE PATTERN DATA			
	GAGE DESIGNATION	RESISTANCE IN OHMS	STD. CREEP CODE
	N2K-XX-S5103R-350/DG/E4	350 ±0.2%	R
DESCRIPTION Dual-element pattern for shear or torque transducers			

GAGE DIMENSIONS					
				inch	millimeter
Grid Length	Overall Length	Grid Width	Overall Width	Matrix Length	Matrix Width
0.075	0.231	0.060	0.202	0.25	0.22
1.91	5.86	1.52	5.13	6.3	5.6

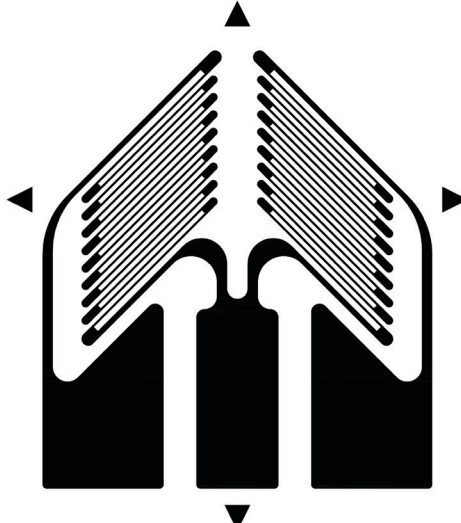

* Only creep code available for this gage.
Copper plating for tabs is available.

Transducer-Class® Strain Gages with Advanced Sensors Technology

S5185 GAGE PATTERN DATA			
  actual size	GAGE DESIGNATION	RESISTANCE IN OHMS	STD. CREEP CODE
	N2A-XX-S5185T-350/E5	350 ±0.2%	T*
DESCRIPTION Three-tab version of S5095 pattern.			 RoHS COMPLIANT

GAGE DIMENSIONS					
				inch	millimeter
Grid Length	Overall Length	Grid Width	Overall Width	Matrix Length	Matrix Width
0.080	0.215	0.056	0.190	0.28	0.25
2.01	5.46	1.43	4.83	7.2	6.4

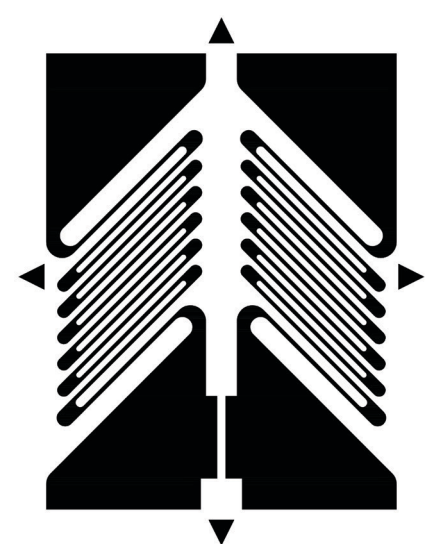
* Only creep code available for this gage.

GAGE PATTERN DATA			
  actual size	GAGE DESIGNATION	RESISTANCE IN OHMS	STD. CREEP CODE
	N2A-XX-S5291V-350/E5 N2K-XX-S5113R-350/DG/E4 N5K-XX-S5113R-350/DG/E4 N2K-XX-S5116Q-10C/DG/E5 N5K-XX-S5116Q-10C/DG/E5 N2K-XX-S5089Q-25C/DG/E5 N5K-XX-S5089Q-25C/DG/E5 N2K-XX-S5040Q-50C/DG/E5 N5K-XX-S5040Q-50C/DG/E5	350 ±0.2% 350 ±0.2% 350 ±0.2% 1000 ±0.2% 1000 ±0.2% 2500 ±0.3% 2500 ±0.3% 5000 ±0.2% 5000 ±0.2%	R R R Q Q Q* Q* Q Q
DESCRIPTION Dual-element patterns for shear or torque transducers.			 RoHS COMPLIANT



GAGE DIMENSIONS					
				inch	millimeter
Grid Length	Overall Length	Grid Width	Overall Width	Matrix Length	Matrix Width
0.075	0.221	0.060	0.170	0.28	0.23
1.91	5.61	1.52	4.32	7.1	5.8

* Only creep code available for this gage.

Copper plating for tabs is available.

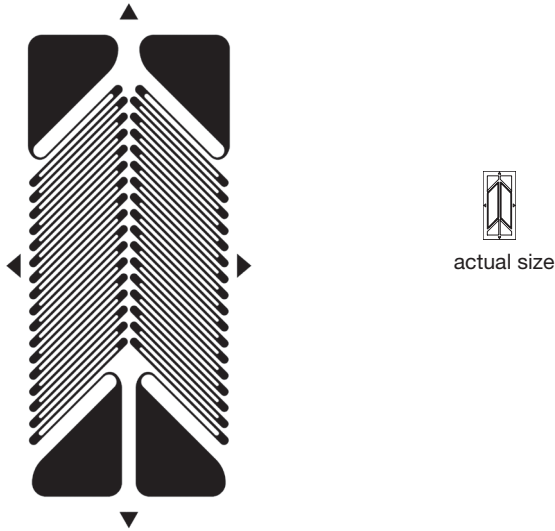

** Grid dimensions may differ from pattern to pattern.

Transducer-Class® Strain Gages with Advanced Sensors Technology

S5147 GAGE PATTERN DATA			
 <p>actual size</p>	GAGE DESIGNATION N2K-XX-S5147P-10C/DG/E4 N5K-XX-S5147P-10C/DG/E4	RESISTANCE IN OHMS 1000 ±0.2% 1000 ±0.2%	STD. CREEP CODE P P
	DESCRIPTION Dual-element pattern for shear or torque transducers.		

GAGE DIMENSIONS					
				inch	millimeter
Grid Length	Overall Length	Grid Width	Overall Width	Matrix Length	Matrix Width
0.071	0.307	0.130	0.126	0.35	0.17
1.80	7.80	3.30	3.20	9.0	4.3

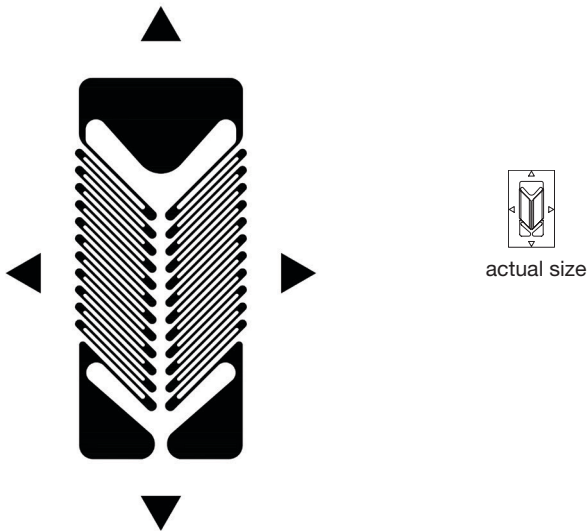

Copper plating for tabs is available.

S5259 GAGE PATTERN DATA			
 <p>actual size</p>	GAGE DESIGNATION N2A-XX-S5259S-350/E5	RESISTANCE IN OHMS 350 ±0.2%	STD. CREEP CODE S*
	DESCRIPTION Dual-element pattern for shear or torque transducers.		

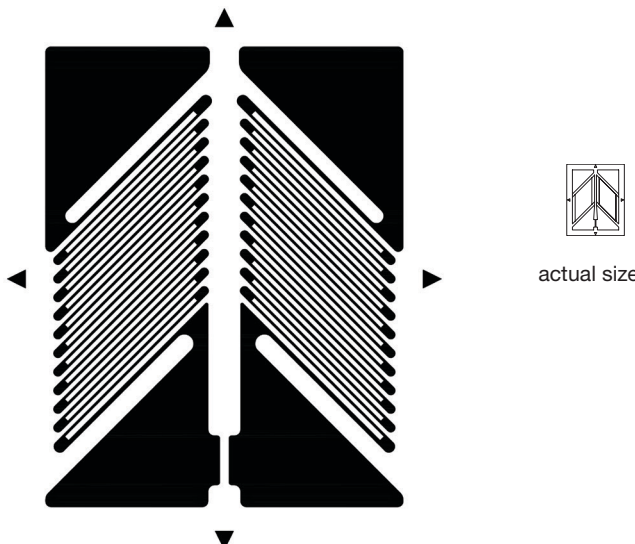

GAGE DIMENSIONS					
				inch	millimeter
Grid Length	Overall Length	Grid Width	Overall Width	Matrix Length	Matrix Width
0.062	0.284	0.106	0.121	0.40	0.24
1.57	7.21	2.69	3.08	10.1	6.1

* Only creep code available for this gage.

Transducer-Class® Strain Gages with Advanced Sensors Technology

S5162 GAGE PATTERN DATA			
	GAGE DESIGNATION	RESISTANCE IN OHMS	STD. CREEP CODE
	N2A-XX-S5162R-350/E4	350 ±0.2%	R
DESCRIPTION Dual-element pattern for shear or torque transducers.			

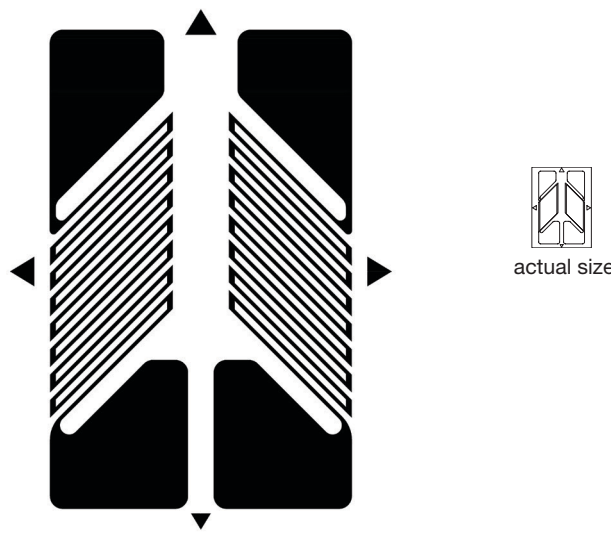
GAGE DIMENSIONS					
				inch	millimeter
Grid Length	Overall Length	Grid Width	Overall Width	Matrix Length	Matrix Width
0.125	0.318	0.100	0.245	0.38	0.30
3.18	8.10	2.54	6.20	9.6	7.7

S5124 GAGE PATTERN DATA			
	GAGE DESIGNATION	RESISTANCE IN OHMS	STD. CREEP CODE
	N2K-XX-S5124K-350/E5 N5K-XX-S5124K-350/E5	350 ±0.2% 350 ±0.2%	K* K*
DESCRIPTION Dual-element pattern for shear or torque transducers.			

GAGE DIMENSIONS					
				inch	millimeter
Grid Length	Overall Length	Grid Width	Overall Width	Matrix Length	Matrix Width
0.125	0.380	0.110	0.240	0.42	0.31
3.18	9.63	2.79	6.06	10.7	7.9

* Only creep code available for this gage.
Copper plating for tabs is available.

Transducer-Class® Strain Gages with Advanced Sensors Technology

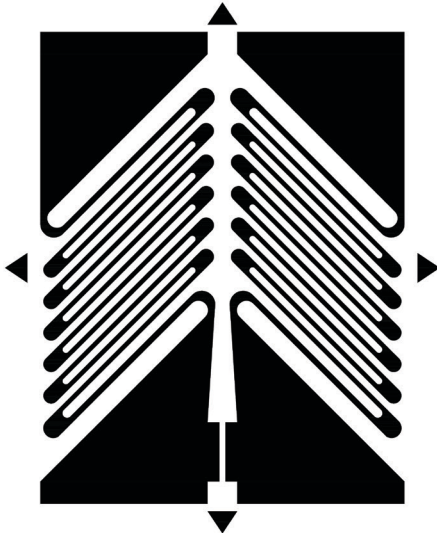
S5364 GAGE PATTERN DATA			
 <p>actual size</p>	GAGE DESIGNATION N2K-XX-S5364Y-350/DG/E5 N5K-XX-S5364Y-350/DG/E5	RESISTANCE IN OHMS 350 ±0.2%	STD. CREEP CODE Y*
	DESCRIPTION Dual-element pattern for shear or torque transducers		

GAGE DIMENSIONS					
				inch	millimeter
Grid Length	Overall Length	Grid Width	Overall Width	Matrix Length	Matrix Width
0.125	0.318	0.100	0.245	0.38	0.31
3.17	8.08	2.54	6.23	9.6	7.8

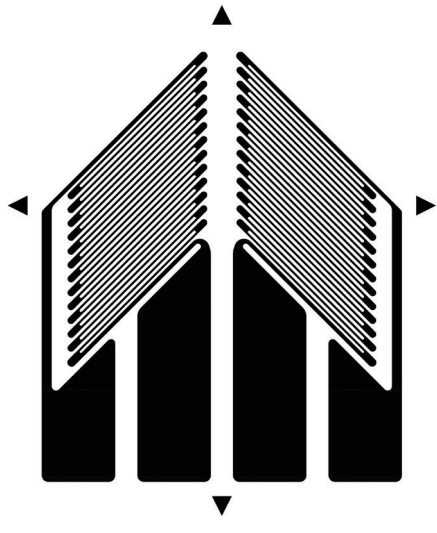

* Only creep code available for this gage.
Copper plating for tabs is available.

S5243 GAGE PATTERN DATA			
 <p>actual size</p>	GAGE DESIGNATION N2A-XX-S5243T-10C/E5	RESISTANCE IN OHMS 1000 ±0.2%	STD. CREEP CODE Q*
	DESCRIPTION Dual-element pattern for shear or torque transducers		

GAGE DIMENSIONS					
				inch	millimeter
Grid Length	Overall Length	Grid Width	Overall Width	Matrix Length	Matrix Width
0.125	0.334	0.100	0.275	0.40	0.34
3.17	8.48	2.54	7.00	10.1	8.5

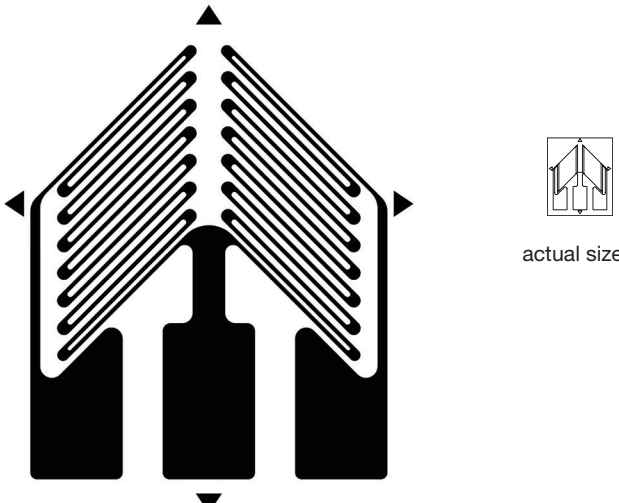

* Only creep code available for this gage.

Transducer-Class® Strain Gages with Advanced Sensors Technology

S5293 GAGE PATTERN DATA			
 <p>actual size</p>	GAGE DESIGNATION	RESISTANCE IN OHMS	STD. CREEP CODE
	N2A-XX-S5293P-350/E5	350 ±0.2%	P*
DESCRIPTION Dual-element pattern for shear or torque transducers			

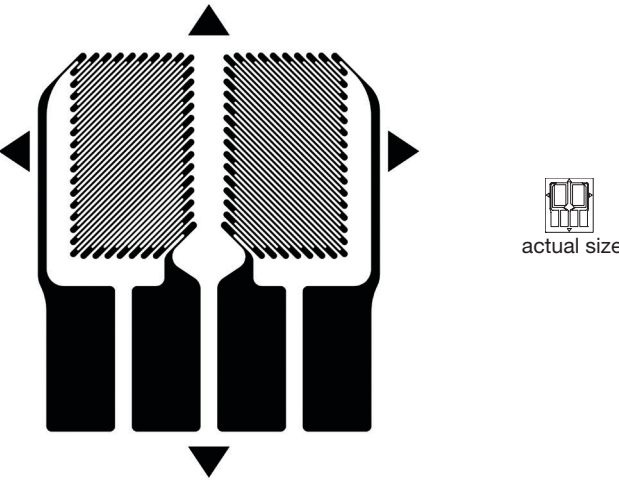

GAGE DIMENSIONS					
				inch	millimeter
Grid Length	Overall Length	Grid Width	Overall Width	Matrix Length	Matrix Width
0.125	0.334	0.100	0.275	0.40	0.34
3.17	8.48	2.54	7.00	10.1	8.5

* Only creep code available for this gage.

S5321 GAGE PATTERN DATA			
 <p>actual size</p>	GAGE DESIGNATION	RESISTANCE IN OHMS	STD. CREEP CODE
	N2A-XX-S5321R-10C/E5	1000 ±0.2%	R*
DESCRIPTION Dual-element pattern for shear or torque transducers			

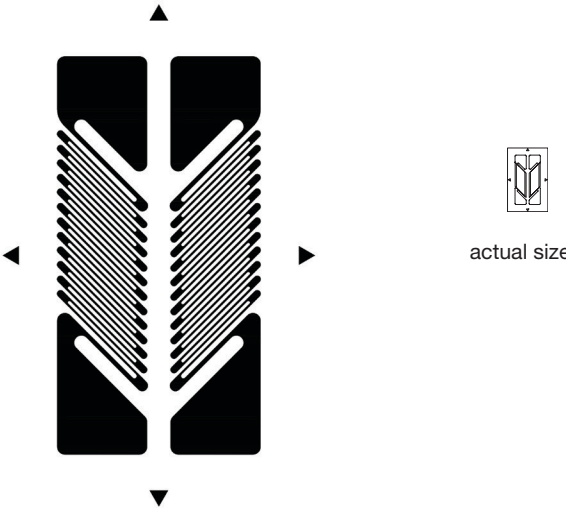

GAGE DIMENSIONS					
				inch	millimeter
Grid Length	Overall Length	Grid Width	Overall Width	Matrix Length	Matrix Width
0.085	0.218	0.119	0.190	0.28	0.25
2.16	5.54	3.02	4.83	7.2	6.4

Transducer-Class® Strain Gages with Advanced Sensors Technology

S5283 GAGE PATTERN DATA						
				GAGE DESIGNATION	RESISTANCE IN OHMS	STD. CREEP CODE
				N2A-XX-S5283Q-500/E5	500 ±0.2%	Q*
DESCRIPTION Dual-element pattern for shear or torque transducers.						
GAGE DIMENSIONS						
				inch	millimeter	
Grid Length	Overall Length	Grid Width	Overall Width	Matrix Length	Matrix Width	
0.062	0.256	0.089	0.131	0.33	0.21	
1.57	6.50	2.26	3.33	8.4	5.3	

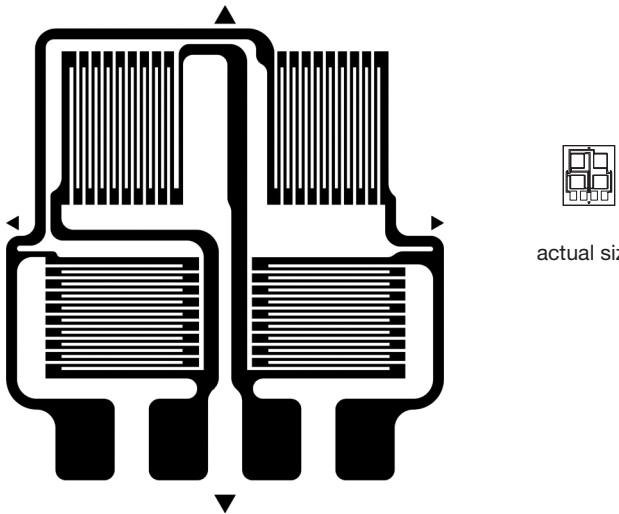

* Only creep code available for this gage.

Transducer-Class® Strain Gages with Advanced Sensors Technology

S5056 GAGE PATTERN DATA					
 <p>actual size</p>	GAGE DESIGNATION	RESISTANCE IN OHMS	STD. CREEP CODE		
	N2K-XX-S5056Q-10C/DG/E5	1000 ±3%	Q*		
	N5K-XX-S5056Q-10C/DG/E5	1000 ±3%	Q*		
DESCRIPTION Full-bridge for bending-beam transducers. Bridge is balanced to ±0.4 mV/V, but RG is 1000 Ω ±3%.					

GAGE DIMENSIONS						inch	millimeter
Grid Length	Overall Length	Grid Width	Overall Width	Matrix Length	Matrix Width		
0.070	0.262	0.070	0.253	0.31	0.27		
1.78	6.66	1.78	6.43	7.9	6.8		

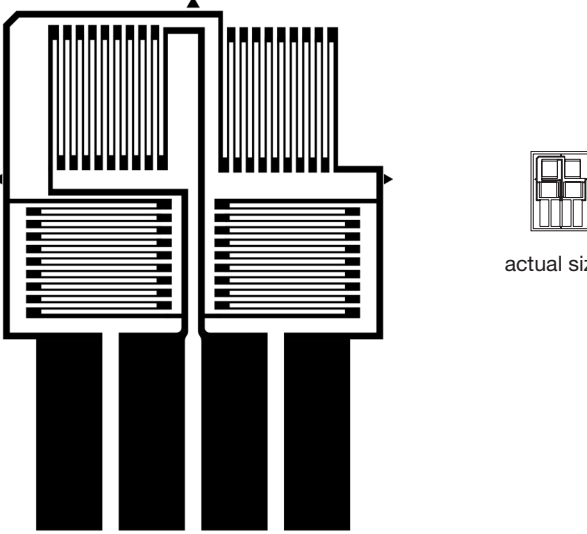

* Only creep code available for this gage.
Copper plating for tabs is available.

S5107 GAGE PATTERN DATA					
 <p>actual size</p>	GAGE DESIGNATION	RESISTANCE IN OHMS	STD. CREEP CODE		
	N2K-XX-S5107Q-12C/DG/E5	1200 ±3%	Q*		
	N5K-XX-S5107Q-12C/DG/E5	1200 ±3%	Q*		
DESCRIPTION Full-bridge for bending-beam transducers. Bridge is balanced to ±0.4 mV/V, but RG is a 1200 Ω ±3%.					

GAGE DIMENSIONS						inch	millimeter
Grid Length	Overall Length	Grid Width	Overall Width	Matrix Length	Matrix Width		
0.070	0.302	0.070	0.190	0.34	0.25		
1.78	7.67	1.78	4.83	8.5	6.4		

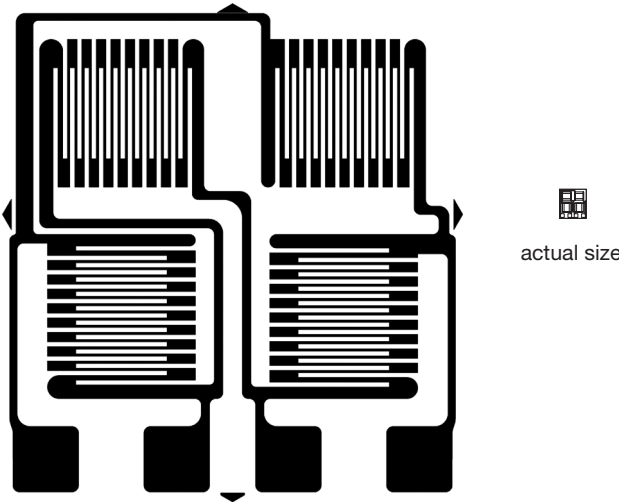

* Only creep code available for this gage.
Copper plating for tabs is available.

Transducer-Class® Strain Gages with Advanced Sensors Technology

S5229 GAGE PATTERN DATA			
	GAGE DESIGNATION	RESISTANCE IN OHMS	STD. CREEP CODE
	N2K-XX-S5229A-50C/DG/E3 N5K-XX-S5229A-50C/DG/E3	5000 ±5% 5000 ±5%	A* A*
DESCRIPTION Miniature high resistance full-bridge. Bridge is balanced to ±0.5 mV/V, but RG is 5000 Ω ±5%.			

GAGE DIMENSIONS					
				inch	millimeter
Grid Length	Overall Length	Grid Width	Overall Width	Matrix Length	Matrix Width
0.028	0.129	0.044	0.134	0.16	0.14
0.71	3.30	1.13	3.41	4.0	3.7

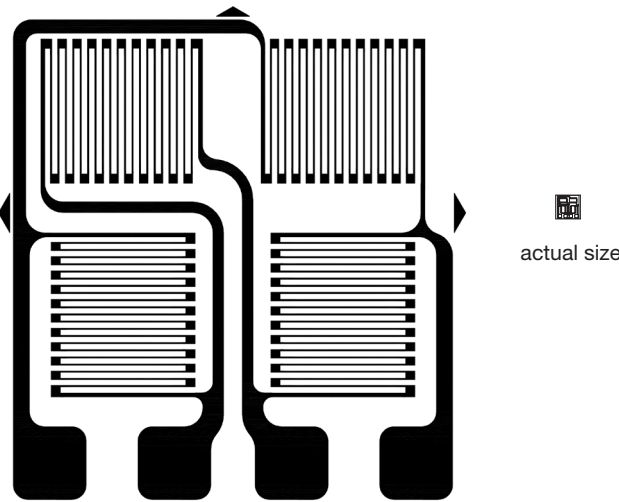

* Only creep code available for this gage.
Copper plating for tabs is available.

S5231 GAGE PATTERN DATA			
	GAGE DESIGNATION	RESISTANCE IN OHMS	STD. CREEP CODE
	N2K-XX-S5231K-20C/DG/E3 N5K-XX-S5231K-20C/DG/E3	2000 ±3% 2000 ±3%	K* K*
DESCRIPTION Miniature high resistance full-bridge. Bridge is balanced to ±0.5 mV/V, but RG is 2000 Ω ±3%.			

GAGE DIMENSIONS					
				inch	millimeter
Grid Length	Overall Length	Grid Width	Overall Width	Matrix Length	Matrix Width
0.020	0.122	0.045	0.120	0.14	0.13
0.51	3.10	1.14	3.05	3.6	3.4

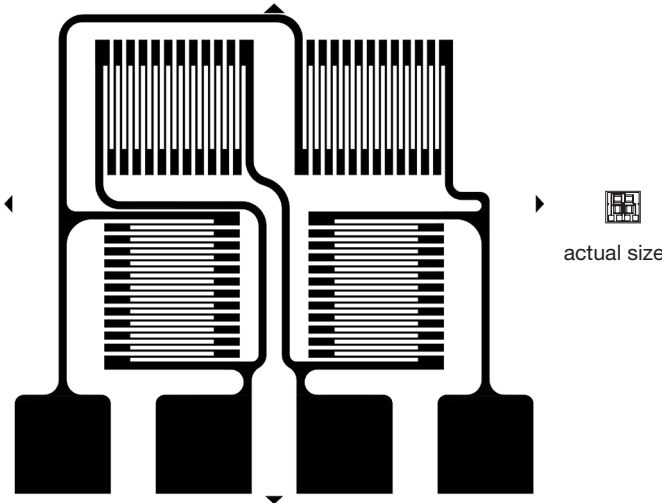

* Only creep code available for this gage.
Copper plating for tabs is available.

Transducer-Class® Strain Gages with Advanced Sensors Technology

S5020 GAGE PATTERN DATA			
	GAGE DESIGNATION	RESISTANCE IN OHMS	STD. CREEP CODE
	N2K-XX-S5020Q-50C/DG/E3 N5K-XX-S5020Q-50C/DG/E3	5000 ±5% 5000 ±5%	Q* Q*
DESCRIPTION Miniature high resistance full-bridge. Bridge is balanced to ±0.4 mV/V, but RG is 5000 Ω ±5%.			

GAGE DIMENSIONS					
				inch	millimeter
Grid Length	Overall Length	Grid Width	Overall Width	Matrix Length	Matrix Width
0.028	0.160	0.050	0.159	0.17	0.18
0.71	4.06	1.27	4.03	4.3	4.7

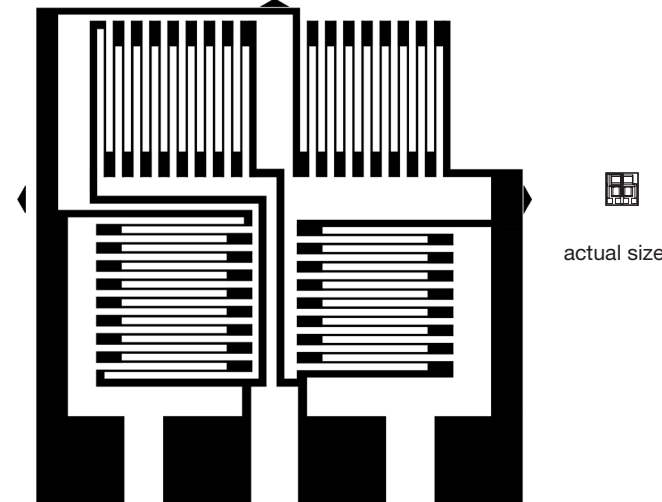

* Only creep code available for this gage.
Copper plating for tabs is available.

S5067 GAGE PATTERN DATA			
	GAGE DESIGNATION	RESISTANCE IN OHMS	STD. CREEP CODE
	N2K-XX-S5067P-10C/DG/E5 N5K-XX-S5067P-10C/DG/E5	1000 ±3% 1000 ±3%	P* P*
DESCRIPTION Small full-bridge for bending-beam transducers. Bridge is balanced to ±0.4 mV/V, but RG is 1000 Ω ±3%.			

GAGE DIMENSIONS					
				inch	millimeter
Grid Length	Overall Length	Grid Width	Overall Width	Matrix Length	Matrix Width
0.033	0.153	0.053	0.158	0.17	0.17
0.85	3.89	1.36	4.02	4.3	4.3

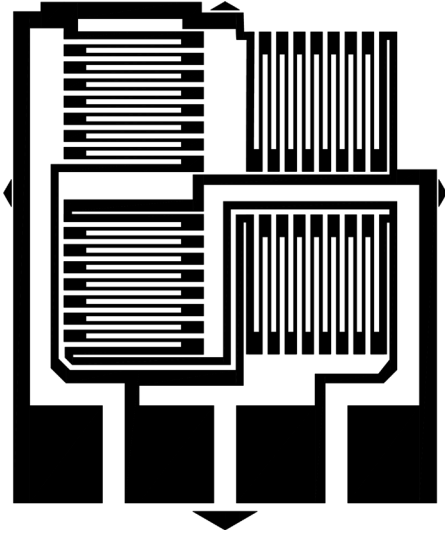

* Only creep code available for this gage.
Copper plating for tabs is available.

Transducer-Class® Strain Gages with Advanced Sensors Technology

S5062 GAGE PATTERN DATA			
 <p>actual size</p>	GAGE DESIGNATION N2K-XX-S5062N-10C/DG/E5 N5K-XX-S5062N-10C/DG/E5	RESISTANCE IN OHMS 1000 ±3% 1000 ±3%	STD. CREEP CODE N* N*
	DESCRIPTION Small full-bridge for bending-beam transducers. Bridge is balanced to ±0.4 mV/V, but RG is 1000 Ω ±3%.		 RoHS COMPLIANT

GAGE DIMENSIONS						inch	millimeter
Grid Length	Overall Length	Grid Width	Overall Width	Matrix Length	Matrix Width		
0.033	0.148	0.057	0.168	0.16	0.19		
0.85	3.76	1.45	4.27	4.2	4.8		

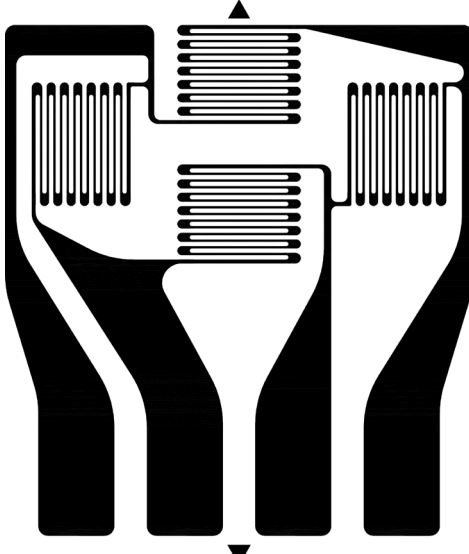

* Only creep code available for this gage.
Copper plating for tabs is available.

S5232 GAGE PATTERN DATA			
 <p>actual size</p>	GAGE DESIGNATION N2A-XX-S5232K-350/E5	RESISTANCE IN OHMS 350 ±3%	STD. CREEP CODE K*
	DESCRIPTION Full-bridge for bending-beam transducers. Bridge is balanced to ±0.4 mV/V, but RG is 350 Ω ±3%.		 RoHS COMPLIANT

GAGE DIMENSIONS						inch	millimeter
Grid Length	Overall Length	Grid Width	Overall Width	Matrix Length	Matrix Width		
0.051	0.262	0.051	0.206	0.30	0.25		
1.30	6.64	1.30	5.23	7.6	6.3		

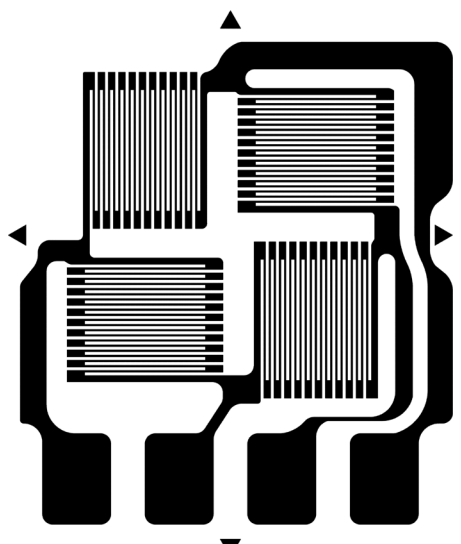

* Only creep code available for this gage.

Transducer-Class® Strain Gages with Advanced Sensors Technology

S5193 GAGE PATTERN DATA			
 <p>actual size</p>	GAGE DESIGNATION	RESISTANCE IN OHMS	STD. CREEP CODE
	N2A-XX-S5193R-350/E5	350 ±3%	R*
DESCRIPTION Full-bridge for bending-beam transducers. Bridge is balanced to ±0.5 mV/V, but RG is 350 Ω ±3%.			 RoHS COMPLIANT

GAGE DIMENSIONS					
				inch	millimeter
Grid Length	Overall Length	Grid Width	Overall Width	Matrix Length	Matrix Width
0.071	0.264	0.071	0.220	0.33	0.27
1.80	6.71	1.80	5.59	8.3	6.8

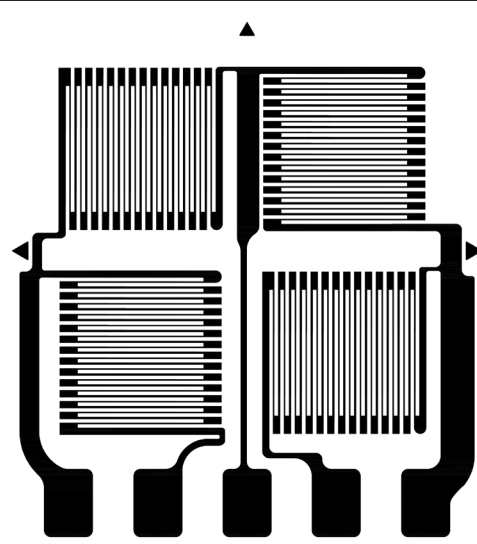

* Only creep code available for this gage.

S5139 GAGE PATTERN DATA			
 <p>actual size</p>	GAGE DESIGNATION	RESISTANCE IN OHMS	STD. CREEP CODE
	N2A-XX-S5139U-350/E4	350 ±0.2%	U*
DESCRIPTION Open full-bridge pattern for single-surface gaging of transducers.			 RoHS COMPLIANT

GAGE DIMENSIONS					
				inch	millimeter
Grid Length	Overall Length	Grid Width	Overall Width	Matrix Length	Matrix Width
0.093	0.345	0.120	0.299	0.40	0.35
2.36	8.77	3.06	7.60	10.3	9.0

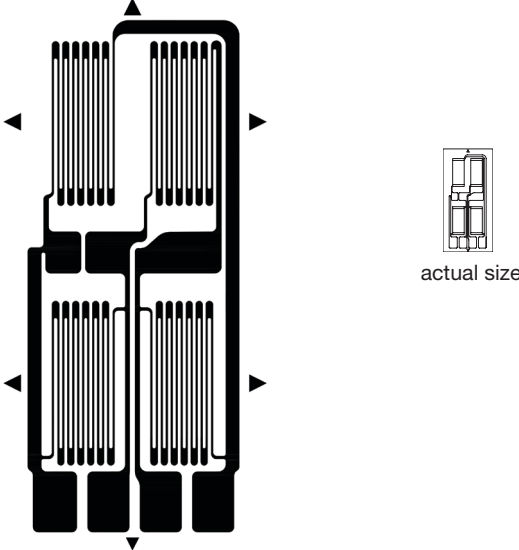

* Only creep code available for this gage.

Transducer-Class® Strain Gages with Advanced Sensors Technology

S5292 GAGE PATTERN DATA					
 <p>actual size</p>	GAGE DESIGNATION	RESISTANCE IN OHMS	STD. CREEP CODE		
	N2A-XX-S5292X-350/E5	350 ±3%	X*		
DESCRIPTION					 RoHS COMPLIANT
Full-bridge pattern for use on double-bending beams. Axial grid centerline spacing 0.250 in (6.35 mm).					

GAGE DIMENSIONS						inch	millimeter
Grid Length	Overall Length	Grid Width	Overall Width	Matrix Length	Matrix Width		
0.125	0.455	0.060	0.192	0.54	0.26		
3.18	11.56	1.52	4.88	13.6	6.6		

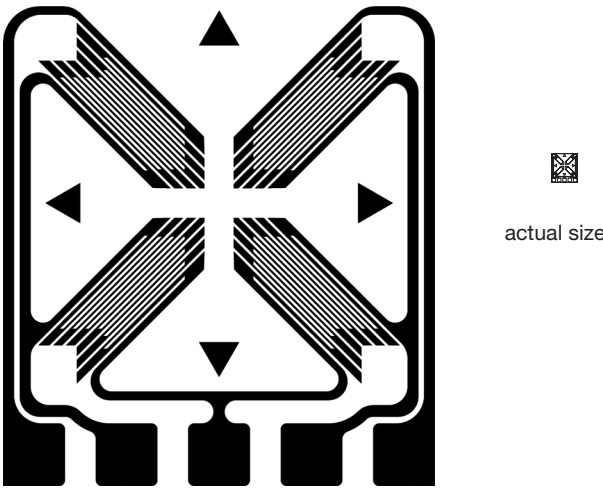

* Only creep code available for this gage.

S5023 GAGE PATTERN DATA					
 <p>actual size</p>	GAGE DESIGNATION	RESISTANCE IN OHMS	STD. CREEP CODE		
	N2K-XX-S5023M-10C/DG/E5 N5K-XX-S5023M-10C/DG/E5	1000 ±0.2% 1000 ±0.2%	M* M*		
DESCRIPTION					 RoHS COMPLIANT
Full-bridge pattern for shear or torque transducers.					

GAGE DIMENSIONS						inch	millimeter
Grid Length	Overall Length	Grid Width	Overall Width	Matrix Length	Matrix Width		
0.045	0.160	0.024	0.144	0.17	0.15		
1.15	4.06	0.61	3.66	4.2	3.8		

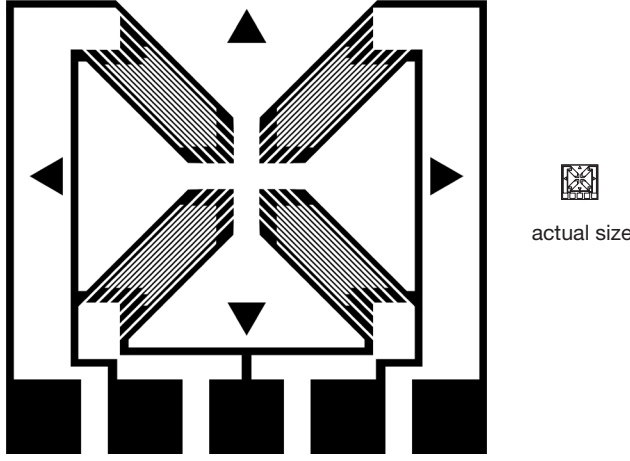

* Only creep code available for this gage.
Copper plating for tabs is available.

Transducer-Class® Strain Gages with Advanced Sensors Technology

S5046 GAGE PATTERN DATA			
 <p>actual size</p>	GAGE DESIGNATION	RESISTANCE IN OHMS	STD. CREEP CODE
	N2K-XX-S5046M-50C/DG/E5	5000 ±0.2%	M*
	N5K-XX-S5046M-50C/DG/E5	5000 ±0.2%	M*
DESCRIPTION Open full-bridge pattern for shear or torque transducers.			 RoHS COMPLIANT

GAGE DIMENSIONS					
				inch	millimeter
Grid Length	Overall Length	Grid Width	Overall Width	Matrix Length	Matrix Width
0.044	0.170	0.024	0.180	0.18	0.19
1.12	4.31	0.61	4.57	4.5	4.8

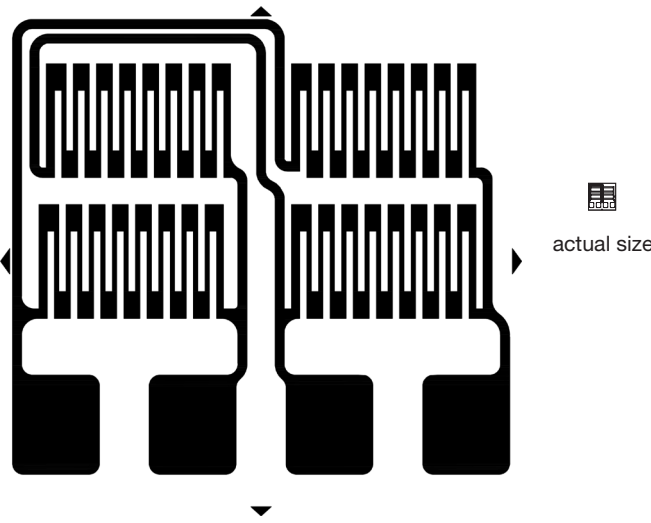

* Only creep code available for this gage.
Copper plating for tabs is available.

S5047 GAGE PATTERN DATA			
 <p>actual size</p>	GAGE DESIGNATION	RESISTANCE IN OHMS	STD. CREEP CODE
	N2K-XX-S5047K-10C/DG/E5	1000 ±3%	K*
	N5K-XX-S5047K-10C/DG/E5	1000 ±3%	K*
DESCRIPTION Compact full-bridge pattern for use on small, double-bending beams. Bridge is balanced to ±0.4 mV/V, but RG is 1000 Ω ±3%.			 RoHS COMPLIANT

GAGE DIMENSIONS					
				inch	millimeter
Grid Length	Overall Length	Grid Width	Overall Width	Matrix Length	Matrix Width
0.017	0.112	0.060	0.137	0.14	0.15
0.43	2.86	1.52	3.49	3.7	3.8

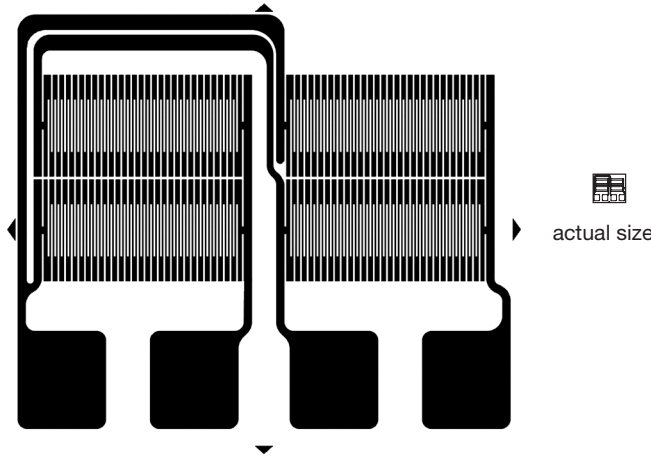

* Only creep code available for this gage.
Copper plating for tabs is available.

Transducer-Class® Strain Gages with Advanced Sensors Technology

S5072 GAGE PATTERN DATA						
				GAGE DESIGNATION	RESISTANCE IN OHMS	STD. CREEP CODE
				N2K-XX-S5072N-10C/DG/E5 N5K-XX-S5072N-10C/DG/E5	1000 ±3% 1000 ±3%	N* N*
DESCRIPTION Compact full-bridge pattern for use on small, double-bending beams. Bridge is balanced to 0.4 mV/V, but RG is 1000 Ω ±3%.						

GAGE DIMENSIONS						inch	millimeter
Grid Length	Overall Length	Grid Width	Overall Width	Matrix Length	Matrix Width		
0.017	0.113	0.064	0.156	0.15	0.17		
0.43	2.86	1.63	3.97	3.7	4.2		

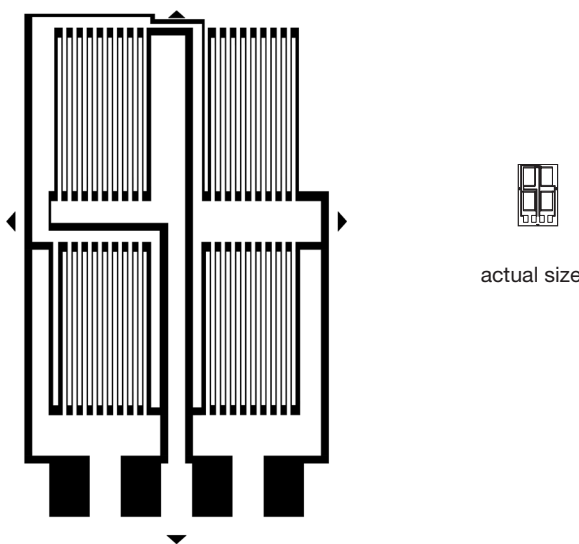

* Only creep code available for this gage.
Copper plating for tabs is available.

S5051 GAGE PATTERN DATA						
				GAGE DESIGNATION	RESISTANCE IN OHMS	STD. CREEP CODE
				N2K-XX-S5051M-11C/DG/E5 N5K-XX-S5051M-11C/DG/E5	1100 ±3% 1100 ±3%	M* M*
DESCRIPTION Full-bridge pattern for double-bending beams. Bridge is balanced to ±0.3 mV/V, but RG is 1100 Ω ±3%.						

GAGE DIMENSIONS						inch	millimeter
Grid Length	Overall Length	Grid Width	Overall Width	Matrix Length	Matrix Width		
0.118	0.376	0.079	0.196	0.42	0.27		
3.00	9.58	2.00	5.00	10.6	6.8		

* Only creep code available for this gage.
Copper plating for tabs is available.

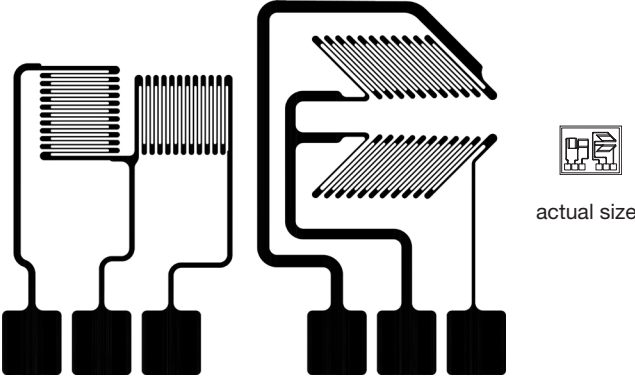

Transducer-Class® Strain Gages with Advanced Sensors Technology

S5060 GAGE PATTERN DATA			
 <p>actual size</p>	GAGE DESIGNATION	RESISTANCE IN OHMS	STD. CREEP CODE
	N2K-XX-S5060-10C/DG/E5 N5K-XX-S5060-10C/DG/E5	1000 ±0.2% 1000 ±0.2%	K, N K, N
DESCRIPTION Half-bridge combination for use in pairs to construct two full-bridges for simultaneous measurement of torsion and axial load.			

GAGE DIMENSIONS					
				inch	millimeter
Grid Length	Overall Length	Grid Width	Overall Width	Matrix Length	Matrix Width
0.033	0.289	0.056	0.210	0.32	0.25
0.85	7.34	1.43	5.33	8.2	6.4

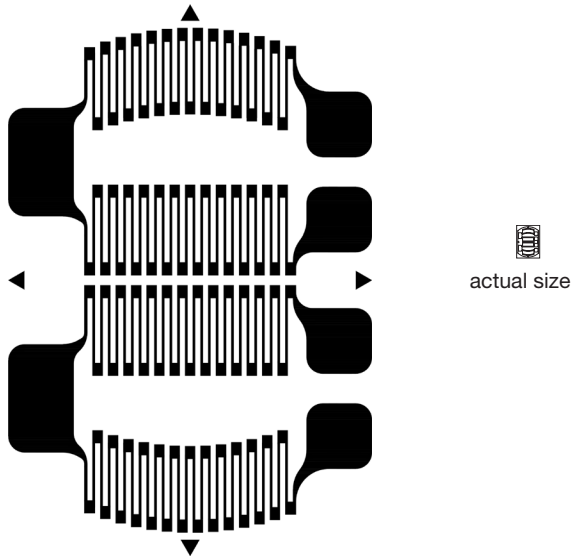

Copper plating for tabs is available.

Transducer-Class® Strain Gages with Advanced Sensors Technology

S5206 GAGE PATTERN DATA			
	GAGE DESIGNATION	RESISTANCE IN OHMS	STD. CREEP CODE
	N2K-XX-S5206F-50C/DG/E5 N5K-XX-S5206F-50C/DG/E5	5000 ±0.3% 5000 ±0.3%	F* F*
DESCRIPTION Full-bridge pattern for use on 0.174 in (4.42 mm) diameter diaphragm.			

GAGE DIMENSIONS					
				inch	millimeter
Grid Length	Overall Length	Grid Width	Overall Width	Matrix Length	Matrix Width
0.019	0.146	0.065	0.111	0.17	0.12
0.48	3.70	1.65	2.82	4.4	3.0

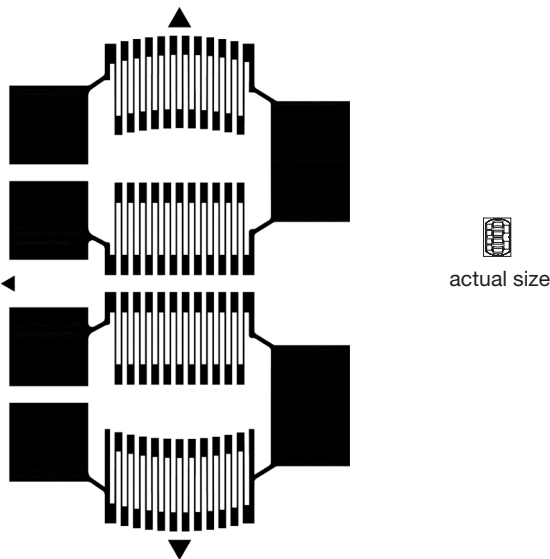

* Only creep code available for this gage.
Copper plating for tabs is available.

GAGE PATTERN DATA			
	GAGE DESIGNATION	RESISTANCE IN OHMS	STD. CREEP CODE
	N2K-XX-S5065M-350/DG/E5 N5K-XX-S5065M-350/DG/E5 N2K-XX-S5021M-50C/DG/E5 N5K-XX-S5021M-50C/DG/E5	350 ±0.3% 350 ±0.3% 5000 ±0.3% 5000 ±0.3%	M* M* M* M*
DESCRIPTION Full-bridge pattern for use on 0.200 in (5.080 mm) diameter diaphragm.			

GAGE DIMENSIONS					
				inch	millimeter
Grid Length	Overall Length	Grid Width	Overall Width	Matrix Length	Matrix Width
0.019	0.168	0.059	0.117	0.20	0.13
0.49	4.27	1.50	2.96	5.1	3.2

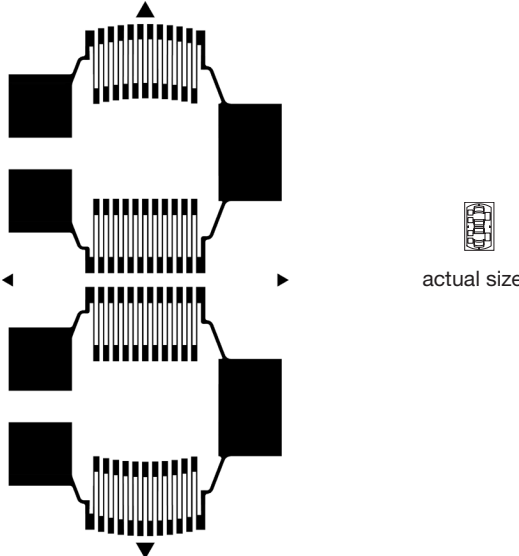

* Only creep code available for this gage.
Copper plating for tabs is available.

Transducer-Class® Strain Gages with Advanced Sensors Technology

GAGE PATTERN DATA			
	GAGE DESIGNATION N2K-XX-S5066M-350/DG/E5 N5K-XX-S5066M-350/DG/E5 N2K-XX-S5022M-50C/DG/E5 N5K-XX-S5022M-50C/DG/E5	RESISTANCE IN OHMS 350 ±0.3% 350 ±0.3% 5000 ±0.3% 5000 ±0.3%	STD. CREEP CODE M* M* M* M*
	DESCRIPTION Full-bridge pattern for use on 0.250 in (6.35 mm) diameter diaphragm.		 RoHS COMPLIANT

GAGE DIMENSIONS					
				inch	millimeter
Grid Length	Overall Length	Grid Width	Overall Width	Matrix Length	Matrix Width
0.020	0.212	0.050	0.112	0.25	0.12
0.51	5.38	1.27	2.84	6.4	3.1

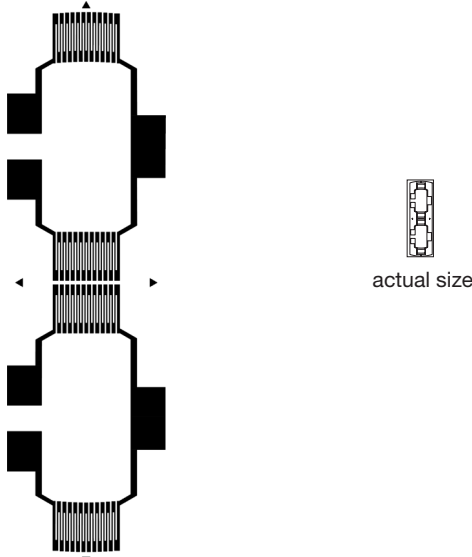

* Only creep code available for this gage.
Copper plating for tabs is available.

S5026 GAGE PATTERN DATA			
	GAGE DESIGNATION N2K-XX-S5026M-50C/DG/E5 N5K-XX-S5026M-50C/DG/E5	RESISTANCE IN OHMS 5000 ±0.3% 5000 ±0.3%	STD. CREEP CODE M* M*
	DESCRIPTION Full bridge pattern for use on 0.400 in (10.16 mm) diameter diaphragm.		 RoHS COMPLIANT

GAGE DIMENSIONS					
				inch	millimeter
Grid Length	Overall Length	Grid Width	Overall Width	Matrix Length	Matrix Width
0.020	0.368	0.044	0.111	0.40	0.12
0.51	9.35	1.12	2.82	10.2	3.1

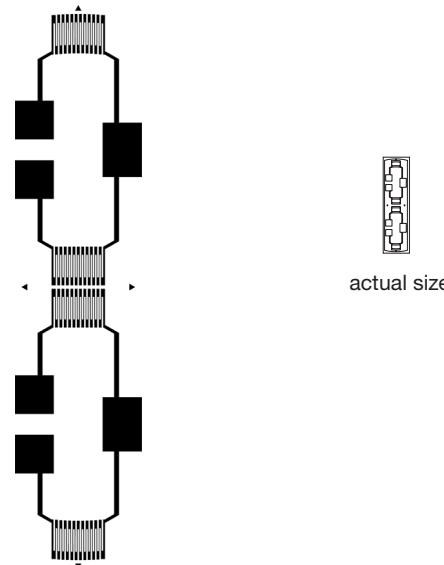

* Only creep code available for this gage.
Copper plating for tabs is available.

Transducer-Class® Strain Gages with Advanced Sensors Technology

S5025 GAGE PATTERN DATA			
 <p>actual size</p>	GAGE DESIGNATION	RESISTANCE IN OHMS	STD. CREEP CODE
	N2K-XX-S5025M-50C/DG/E5 N5K-XX-S5025M-50C/DG/E5	5000 ±0.3% 5000 ±0.3%	M* M*
DESCRIPTION Full-bridge pattern for use on 0.500 in (12.7 mm) diameter diaphragm.			

GAGE DIMENSIONS					
				inch	millimeter
Grid Length	Overall Length	Grid Width	Overall Width	Matrix Length	Matrix Width
0.020	0.483	0.047	0.111	0.50	0.12
0.51	12.26	1.19	2.82	12.7	3.1

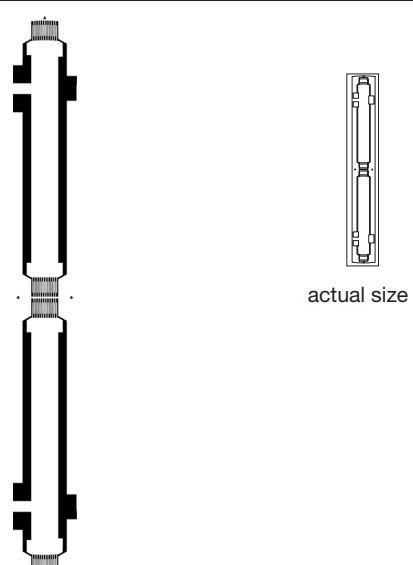

* Only creep code available for this gage.
Copper plating for tabs is available.

S5071 GAGE PATTERN DATA			
 <p>actual size</p>	GAGE DESIGNATION	RESISTANCE IN OHMS	STD. CREEP CODE
	N2K-XX-S5071M-50C/DG/E5 N5K-XX-S5071M-50C/DG/E5	5000 ±0.3% 5000 ±0.3%	M* M*
DESCRIPTION Full-bridge pattern for use on 1.00 in (25.4 mm) diameter diaphragm.			

GAGE DIMENSIONS					
				inch	millimeter
Grid Length	Overall Length	Grid Width	Overall Width	Matrix Length	Matrix Width
0.020	0.968	0.047	0.111	1.00	0.12
0.51	24.59	1.19	2.82	25.4	3.1

* Only creep code available for this gage.
Copper plating for tabs is available.

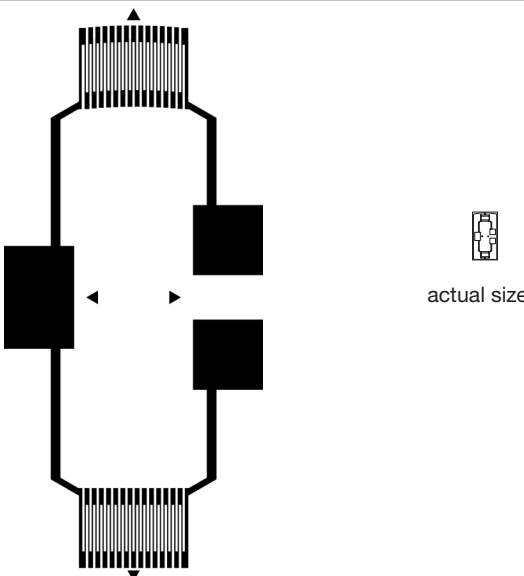

Transducer-Class® Strain Gages with Advanced Sensors Technology

S5050 GAGE PATTERN DATA			
	GAGE DESIGNATION	RESISTANCE IN OHMS	STD. CREEP CODE
	N2K-XX-S5050M-30C/DG/E5 N5K-XX-S5050M-30C/DG/E5	3000 ±0.3% 3000 ±0.3%	M* M*
DESCRIPTION Half-bridge diaphragm configuration.			

GAGE DIMENSIONS					
				inch	millimeter
Grid Length	Overall Length	Grid Width	Overall Width	Matrix Length	Matrix Width
0.020	0.217	0.047	0.111	0.25	0.13
0.51	5.52	1.19	2.82	6.4	3.2

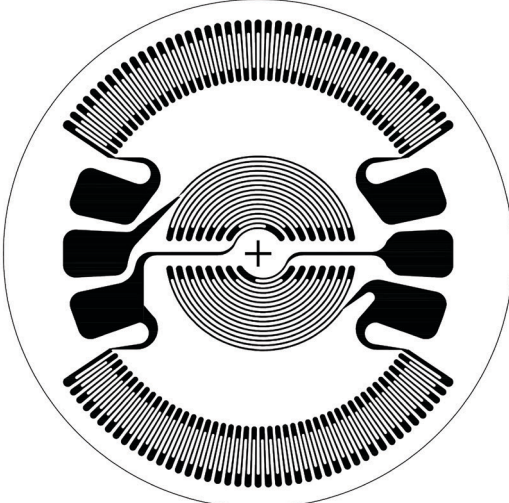

* Only creep code available for this gage.
Copper plating for tabs is available.

Transducer-Class® Strain Gages with Advanced Sensors Technology

S5294 GAGE PATTERN DATA			
	GAGE DESIGNATION	RESISTANCE IN OHMS	STD. CREEP CODE
	N2K-XX-S5294H-350/DP/E4 N5K-XX-S5294H-350/DP/E4	350 ±0.2% 350 ±0.2%	R* R*
DESCRIPTION Full-bridge pattern for use on 0.250 in (6.35 mm) diameter diaphragm			 RoHS COMPLIANT

GAGE DIMENSIONS			
		inch	millimeter
Pattern Diameter	Circular Trim Diameter	Outer G.L.	Inner G.L.
0.218	0.250	0.018	0.037
5.52	6.35	0.44	0.95

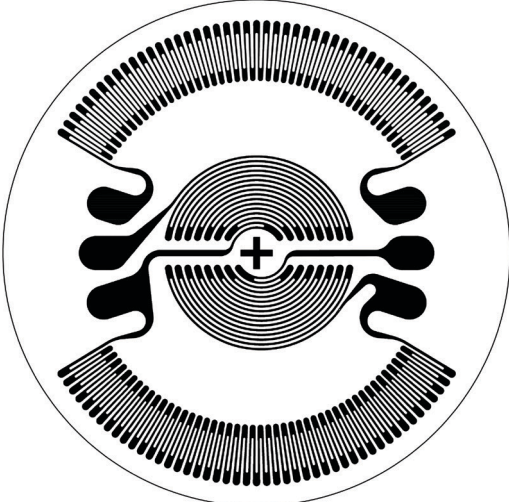

* Only creep code available for this gage.
Copper plating for tabs is available.

S5214 GAGE PATTERN DATA			
	GAGE DESIGNATION	RESISTANCE IN OHMS	STD. CREEP CODE
	N2A-XX-S5214R-350/E5	350 ±0.2%	R*
DESCRIPTION Full-bridge pattern for use on 0.400 in (10.16 mm) diameter diaphragm.			 RoHS COMPLIANT

GAGE DIMENSIONS			
		inch	millimeter
Pattern Diameter	Circular Trim Diameter	Outer G.L.	Inner G.L.
0.368	0.400	0.028	0.063
9.34	10.16	0.71	1.59

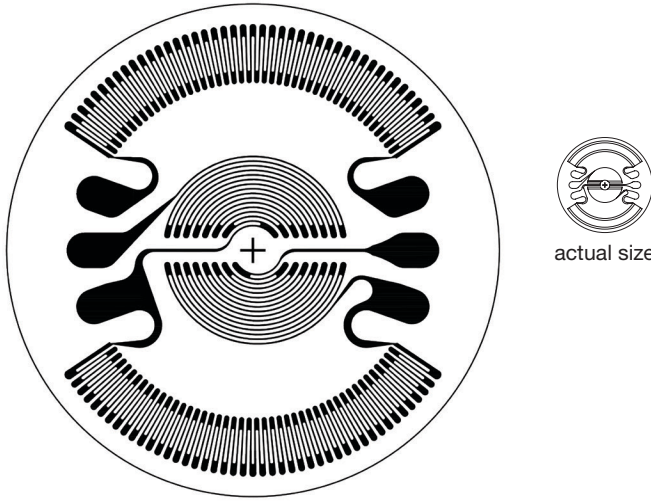

* Only creep code available for this gage.

Transducer-Class® Strain Gages with Advanced Sensors Technology

S5374 GAGE PATTERN DATA			
	GAGE DESIGNATION	RESISTANCE IN OHMS	STD. CREEP CODE
	N2K-XX-S5374R-350/DP/E4 N5K-XX-S5374R-350/DP/E4	350 ±0.2% 350 ±0.2%	R* R*
DESCRIPTION Full-bridge pattern for use on 0.500 in (12.70 mm) diameter diaphragm.			

GAGE DIMENSIONS				inch	millimeter
Pattern Diameter	Circular Trim Diameter	Outer G.L.	Inner G.L.		
0.436	0.500	0.035	0.065		
11.04	12.70	0.88	1.65		

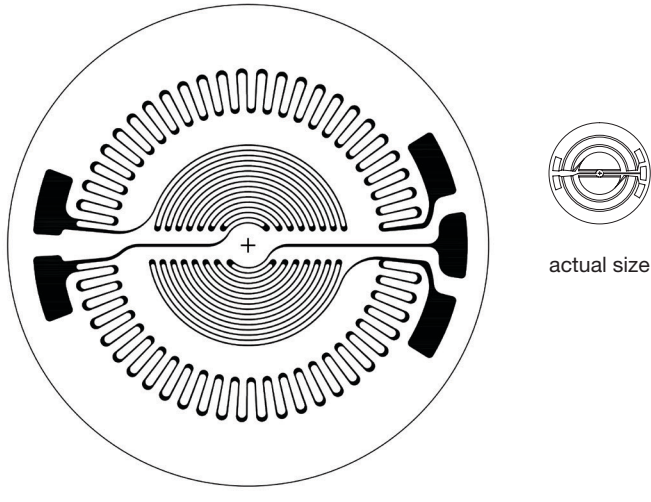
* Only creep code available for this gage.
Copper plating for tabs is available.

S5213 GAGE PATTERN DATA			
	GAGE DESIGNATION	RESISTANCE IN OHMS	STD. CREEP CODE
	N2K-XX-S5213D-35C/DG/E5 N5K-XX-S5213D-35C/DG/E5	3500 ±1% 3500 ±1%	D* D*
DESCRIPTION Full-bridge pattern for use on 0.335 in (8.51 mm) diameter diaphragm.			

GAGE DIMENSIONS				inch	millimeter
Pattern Diameter	Circular Trim Diameter	Outer G.L.	Inner G.L.		
0.240	0.335	0.025	0.057		
6.10	8.51	0.64	1.46		

* Only creep code available for this gage.
Copper plating for tabs is available.

Introduction and Designation System

Micro-Measurements manufactures a variety of fixed, adjustable, and combination bondable resistors for use in many applications where precise resistance is required. Appropriate patterns are available in both low and high temperature-coefficient-of-resistance types. Widest use is in transducer bridge circuits to compensate for small temperature-induced errors and to adjust bridge-balance output.¹ Figure 1 (on the next page) shows a typical application.

Various foil types, sizes, and patterns are available, allowing selection of the optimum resistor for specific applications. Resistors are normally produced open-faced on the flexible E or N2 polyimide backings. The recommended temperature range is 0° to +350°F [-20° to +175°C] for the E type and 0° to +300°F [-20° to +150°C] for the N2. Standard packaging for bondable resistors is 50 per package.

TEMPERATURE-COMPENSATED RESISTORS

Temperature-compensated A alloy and K alloy are available in several resistor patterns. Due to the difficulty of directly soldering to K alloy, all N2K resistors are supplied with a copper soldering pad (DP) on each tab.

TEMPERATURE-SENSITIVE RESISTORS

Three different foil materials are available to fit a variety of compensation requirements.

Nickel—Pure nickel has the highest resistance-versus-temperature sensitivity of the three available foil types and is normally selected for span-versus-temperature compensation. It can be ordered as a fixed resistance value (A Pattern) or adjustable (B Pattern). The temperature coefficient of resistance (TCR) for nickel is +0.33%/°F [+0.59%/°C] over a temperature range of +50° to +150°F [+10° to +65°C].

Balco[®]—Although having a slightly lower TCR than nickel, Balco has a higher resistivity, which makes higher resistance values more easily obtained. It also has some price advantage over nickel. The TCR for Balco is +0.24%/°F [+0.43%/°C] over a temperature range of +50° to +150°F [+10° to +65°C].

Note: Since resistance-versus-temperature for nickel and Balco is not a linear function, values are given as chord slopes over the specified temperature range.

Copper—Pure copper has the lowest TCR of the three materials and also very low resistivity. This makes it ideal for minor adjustments when used in a corner

compensation approach (see Fig. 1). Copper also has a more linear TCR than either Balco or nickel. When used for span-versus-temperature correction, copper can produce a more linear span compensation in some transducer designs. Copper TCR is +0.22%/°F [+0.40%/°C].

RESISTANCE TOLERANCES

A-Pattern resistors have fixed values (selected by the user) and are supplied with tight tolerances. With adjustable types, it is impractical to supply precise values. Most resistors will be within ±20% of the specified nominal values, but occasionally resistances will fall outside that range. The various cutting steps will follow the same trend.

RECOMMENDED ADHESIVES

M-Bond 610, M-Bond 43-B or M-Bond 450 adhesive should be used for operation over the widest temperature range. Other standard strain gage adhesives are acceptable within their recommended temperature limits. The special backing treatment used permits good bond formation with all strain gage adhesives except the solvent-evaporation-setting type. Resistors should be mounted in areas of low strain (preferably less than 500μ ϵ) and on relatively flat surfaces. If possible, grids should be aligned with the direction of lowest strain.

INSTALLATION AND WIRING

All resistor patterns should be bonded to the mounting surface before adjustment or use. Prepare the specimen surface and install the resistor using standard strain gage materials and techniques. Install leadwires, and solder to the attachment tabs with an appropriate solder.

After thorough flux removal, blot with clean sponges, and allow the surface of the resistor to dry completely. Attach leadwires to an appropriate resistance-measuring instrument and adjust the resistor as described in “Adjustment Instructions” until the desired resistance is achieved.

PROTECTIVE COATINGS

For maximum long-term stability, coat the adjusted resistors with a hard, heat-curing material such as Micro-Measurements M-Bond 610, 43-B, or 450. Satisfactory results may be obtained with appropriate air-drying coatings.

¹ “Strain Gage Based Transducers—Their Design and Construction.” Available from Micro-Measurements

² Balco[®] is a registered trademark of W.B. Driver Company

Introduction and Designation System

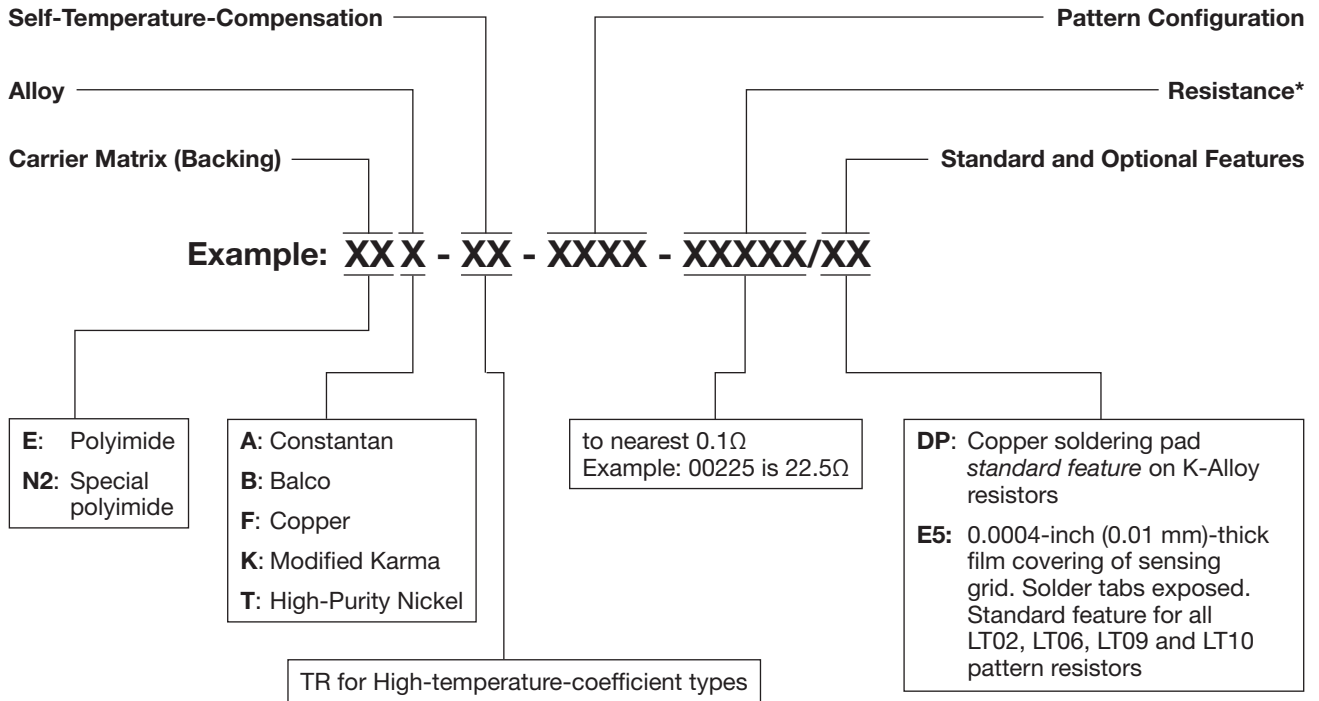

***Note:** It is impossible to guarantee initial or final resistance on adjustable resistor types. Most resistors will be within ±20% of the nominal values given.

FIG. 1. BRIDGE CIRCUIT WITH TYPICAL COMPENSATION RESISTORS

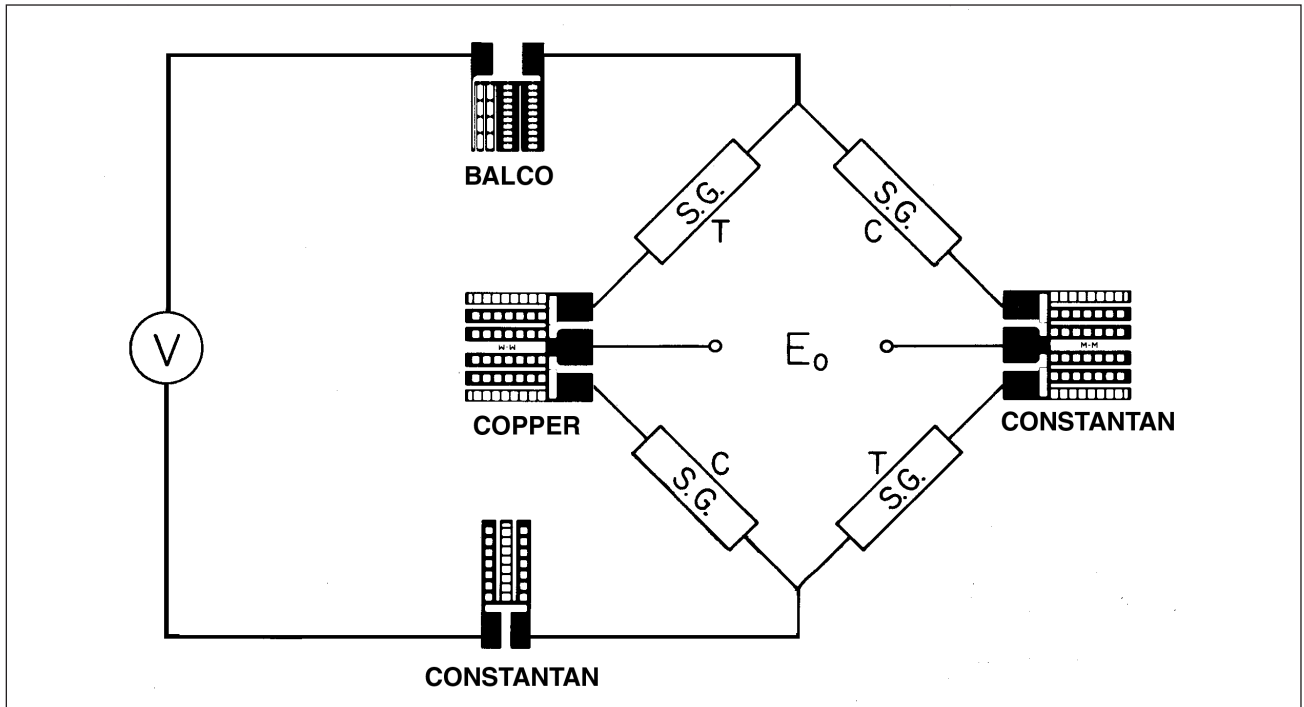

Bondable Resistors for Transducers – Selection Chart

N2B Balco resistors are available in our LT02 and LT06 sizes.

N2T Nickel resistors are available in our LT02, LT06, LT09 and LT10 sizes. The standard resistance values for each are as shown. Custom resistance values are available for a small set-up charge and 500-piece minimum order.

Resistance tolerance is $\pm 1\%$ at $+75^\circ\text{F}$ ($+24^\circ\text{C}$).

Recommended Uses:

- span-shift-versus-temperature compensation
- temperature sensing





Construction

Fixed pattern resistors are normally manufactured and stocked with E5 encapsulation as standard. Solder tabs are left exposed for leadwire connections.

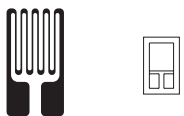

Examples:

N2B-TR-LT06-00200/E5, N2T-TR-LT02-00250/E5.

Resistance tolerance on Option E5 versions is $\pm 1\%$ at $+75^\circ\text{F}$ ($+24^\circ\text{C}$).

GAGE PATTERN AND DESIGNATION Matrix is shown at actual size. Insert Desired Resistors Size in Spaces Marked XX.		STANDARD RESISTANCE RANGE IN OHMS	DIMENSIONS																																			
					inch	millimeter																																
			PATTERN		MATRIX																																	
			Length	Width	Length	Width																																
<p>LT02</p>  <p>LT06</p> 	<p>Nickel options: N2T-TR-LTXX-00150 N2T-TR-LTXX-00175 N2T-TR-LTXX-00200 N2T-TR-LTXX-00250 N2T-TR-LTXX-00300 N2T-TR-LTXX-00400 N2T-TR-LTXX-00600 N2T-TR-LTXX-00650 N2T-TR-LTXX-00700</p> <p>Balco options: N2B-TR-LTXX-00150 N2B-TR-LTXX-00175 N2B-TR-LTXX-00200 N2B-TR-LTXX-00250 N2B-TR-LTXX-00300 N2B-TR-LTXX-00400 N2B-TR-LTXX-00600 N2B-TR-LTXX-00650 N2B-TR-LTXX-00700</p>	15	<table border="1"> <thead> <tr> <th colspan="4">LT02</th> </tr> <tr> <th>Length</th> <th>Width</th> <th>Length</th> <th>Width</th> </tr> </thead> <tbody> <tr> <td>0.24</td> <td>0.13</td> <td>0.30</td> <td>0.19</td> </tr> <tr> <td>6.1</td> <td>3.2</td> <td>7.5</td> <td>4.7</td> </tr> <tr> <th colspan="4">LT06</th> </tr> <tr> <td>0.19</td> <td>0.13</td> <td>0.24</td> <td>0.18</td> </tr> <tr> <td>4.8</td> <td>3.3</td> <td>6.1</td> <td>4.6</td> </tr> <tr> <td colspan="4" style="text-align: center;">RoHS compliant.</td> </tr> </tbody> </table>				LT02				Length	Width	Length	Width	0.24	0.13	0.30	0.19	6.1	3.2	7.5	4.7	LT06				0.19	0.13	0.24	0.18	4.8	3.3	6.1	4.6	RoHS compliant.			
		LT02																																				
		Length					Width	Length	Width																													
		0.24					0.13	0.30	0.19																													
		6.1					3.2	7.5	4.7																													
		LT06																																				
		0.19					0.13	0.24	0.18																													
		4.8					3.3	6.1	4.6																													
		RoHS compliant.																																				
		17.5																																				
20																																						
25																																						
30																																						
40																																						
60																																						
65																																						
70																																						
15	<table border="1"> <thead> <tr> <th colspan="4">LT09</th> </tr> <tr> <th>Length</th> <th>Width</th> <th>Length</th> <th>Width</th> </tr> </thead> <tbody> <tr> <td>0.12</td> <td>0.11</td> <td>0.13</td> <td>0.12</td> </tr> <tr> <td>3.0</td> <td>2.7</td> <td>3.3</td> <td>3.0</td> </tr> <tr> <th colspan="4">LT10</th> </tr> <tr> <td>0.08</td> <td>0.07</td> <td>0.09</td> <td>0.07</td> </tr> <tr> <td>2.1</td> <td>1.8</td> <td>2.5</td> <td>1.9</td> </tr> <tr> <td colspan="4" style="text-align: center;">RoHS compliant.</td> </tr> </tbody> </table>				LT09				Length	Width	Length	Width	0.12	0.11	0.13	0.12	3.0	2.7	3.3	3.0	LT10				0.08	0.07	0.09	0.07	2.1	1.8	2.5	1.9	RoHS compliant.					
LT09																																						
Length					Width	Length	Width																															
0.12					0.11	0.13	0.12																															
3.0					2.7	3.3	3.0																															
LT10																																						
0.08					0.07	0.09	0.07																															
2.1					1.8	2.5	1.9																															
RoHS compliant.																																						
17.5																																						
20																																						
25																																						
30																																						
40																																						
60																																						
65																																						
70																																						
<p>LT09</p>  <p>LT10</p> 	<p>Nickel options: N2T-TR-LTXX-00100 N2T-TR-LTXX-00125 N2T-TR-LTXX-00150 N2T-TR-LTXX-00200 N2T-TR-LTXX-00225 N2T-TR-LTXX-00300 N2T-TR-LTXX-00400 N2T-TR-LTXX-00450 N2T-TR-LTXX-00500 N2T-TR-LTXX-00600 N2T-TR-LTXX-00720 N2T-TR-LTXX-00800 N2T-TR-LTXX-00900</p>	10	<table border="1"> <thead> <tr> <th colspan="4">LT09</th> </tr> <tr> <th>Length</th> <th>Width</th> <th>Length</th> <th>Width</th> </tr> </thead> <tbody> <tr> <td>0.12</td> <td>0.11</td> <td>0.13</td> <td>0.12</td> </tr> <tr> <td>3.0</td> <td>2.7</td> <td>3.3</td> <td>3.0</td> </tr> <tr> <th colspan="4">LT10</th> </tr> <tr> <td>0.08</td> <td>0.07</td> <td>0.09</td> <td>0.07</td> </tr> <tr> <td>2.1</td> <td>1.8</td> <td>2.5</td> <td>1.9</td> </tr> <tr> <td colspan="4" style="text-align: center;">RoHS compliant.</td> </tr> </tbody> </table>				LT09				Length	Width	Length	Width	0.12	0.11	0.13	0.12	3.0	2.7	3.3	3.0	LT10				0.08	0.07	0.09	0.07	2.1	1.8	2.5	1.9	RoHS compliant.			
		LT09																																				
		Length					Width	Length	Width																													
		0.12					0.11	0.13	0.12																													
		3.0					2.7	3.3	3.0																													
		LT10																																				
		0.08					0.07	0.09	0.07																													
		2.1					1.8	2.5	1.9																													
		RoHS compliant.																																				
		12.5																																				
15																																						
20																																						
22.5																																						
30																																						
40																																						
45																																						
50																																						
60																																						
72																																						
80																																						
90																																						

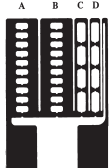
Bondable Resistors for Transducers – Selection Chart

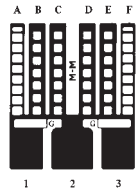
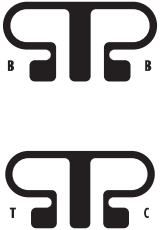
GAGE PATTERN AND DESIGNATION Actual size shown on right Insert Desired S-T-C No. in Spaces Marked XX. See Note 1	RESISTANCE IN OHMS		DIMENSIONS			
			PATTERN		MATRIX	
			Length	Width	Length	Width
 N2B-TR-C11A-00050 N2B-TR-C12A-00100 N2B-TR-C12A-00200 N2B-TR-C13A-00400 N2B-TR-C13A-00800	Before Cut 5 10 20 40 80	After Cut 12 24 48 96 192	0.30	0.20	0.34	0.23
			7.6	5.1	8.6	5.9
 N2F-TR-D01A-00005 N2B-TR-D01A-00060 N2A-XX-D01A-00180 EA-XX-D01A-00360 N2K-XX-D01A-00500/DP N2K-XX-D01A-00750/DP	0.5 6 18 36 50 75		0.35	0.14	0.41	0.20
			8.9	3.6	10.4	5.1
 N2F-TR-E01A-00005 N2A-XX-E01A-00060 N2A-XX-E01A-00180 EA-XX-E01A-00360 N2K-XX-E01A-00500/DP N2K-XX-E01A-00750/DP	0.5 6 18 36 50 75		0.35	0.30	0.41	0.36
			8.9	7.6	10.4	9.1
 N2A-XX-H21A-00025 N2A-XX-H21A-00060 N2B-TR-H22A-00010	2.5 6.0 1.0		0.15	0.29	0.21	3.5
			3.8	7.4	5.3	8.9

RESISTANCE WIRE

While wire does not track the temperature of the strain gages as closely as bondable resistors, there are instances where bondable resistors cannot be used due to limited mounting space. Micro-Measurements stocks two types of resistance wire alloys.

CATALOG NO./ WIRE ALLOY	QTY PER SPOOL	RESISTANCE PER FT (M) NOMINAL	TCR [-10° TO +50°C]	INSULATION	TEMPERATURE RANGE
137-HWN/Manganin	200 ft [61m]	14Ω (46Ω)	± 0.0011%/°F [± 0.002%/°C]	Enamel	+15° to +120°F [-10° to +50°C] (up to +175°F [+80°C] if proper aging is done)
142-JWN/Balco	500 ft [152m]	19Ω (62Ω)	+0.25%/°F [+0.45%/°C]	Enamel	-15° to +300°F [-10° to +150°C]

NOTE 1: All products are RoHS compliant.

Bondable Resistors for Transducers

B PATTERN

The B Pattern bondable resistor is adjusted (decrease in resistance) by shorting out the parallel conducting lines at a desired point along their length. Depending on required stability, shorting can be accomplished through use of a suitable solder or a conductive silver compound.

RECOMMENDED ADJUSTMENT MATERIALS

Solders

63-36.65-0.35 tin-lead-antimony (MM Part No. 361A-20R). Maximum service temperature is +300°F [+150°C].

Conductive Silver (Air-Drying)

#FH-1629 (Acheson Colloids Company)

#8030 (DuPont Electrochemicals Department)

C, D, AND E PATTERNS

Patterns C, D, and E resistors are adjusted (increase in resistance) by cutting various foil bars.

Using an appropriate degree of magnification (preferably under a stereoscopic zoom microscope), locate the cutting points on the resistor pattern. Cuts may be made with the tip of a scalpel blade, or with a tool made by slightly flattening the end of a dental probe (MM Part No. DPR-1). Lightly cut through each end of the shorting bar and lift out the center section, leaving a path clear of foil. Care must be taken to avoid cutting through the backing to the specimen.

The approximate cuts to produce a desired overall pattern resistance can be estimated from the following information for the appropriate pattern; however, many variations may be employed and experimentation may be required to determine the optimum cutting sequence. For example: If steps are cut progressively downward starting from the top of any ladder (for all above patterns), very small changes in resistance are produced. Cuts made in this manner will represent larger changes as the step nearest the large solder tabs is approached.

Note that the actual resistance increase caused by cutting any given step can vary up to 20% of the nominal value. Therefore, it is desirable to plan a series of cuts that will allow the final resistance value to be approached slowly enough to avoid overadjustment. Fine adjustment can also be achieved by gently polishing active portions of the network with 325-mesh alumina powder. This procedure is not recommended when maximum stability is required, however.

C Pattern

The resistance changes produced by cutting the various adjustment steps are specified in terms of R_{MIN} , the uncut pattern resistance. The tabulated data are typical, and were obtained by cutting progressively upward starting with the step nearest the soldering tabs in each respective ladder.

NOTE: Although there are several variations of the C Pattern, the same respective 28 adjusting steps are available in each.

LADDER	APPROX. ΔR AS % R_{MIN}
A	1
B	1
C	10
D	20

D AND E PATTERNS

The resistance values listed for these patterns are the maximum obtainable – after cutting all the ladder steps except the top rung of each row. For the E Pattern, the resistance is measured between terminals 1 and 2, or 2 and 3, with the corresponding shunt (G) cut.

Referring to the pattern diagram for the D resistor, when cutting progressively upward on the center ladder, each step will correspond roughly to an increment of 5.6% of R_{MAX} . The outside ladders provide finer adjustment with each upward step, about 3.4% R_{MAX} .

The shunt (G) in each network of the E Pattern reduces uncut resistance approximately 25%, and reduces adjustment increments of ladders A, B, E and F about 50% to increase resolution. With the shunts uncut, the resistance changes produced by cutting each upward step of ladders A through F as a percentage of R_{MAX} are approximately 2.8%, 1.7%, 3.4%, 3.4%, 1.7% and 2.8%, respectively. R_{MIN} for these patterns is about 0.08 R_{MAX} .

With the shunts (G) cut, the E Pattern is essentially two D resistors with a common solder tab.

H21A AND H22A PATTERNS

H21A

The H21A resistor is designed to be wired into a corner of the Wheatstone bridge like the Constantan E01A pattern shown in Figure 1 in Bondable Resistors for Transducers. Resistance adjustment for zero balance is accomplished by rubbing the appropriate loop of the H21A with a soft pencil eraser. An electric eraser can be used to speed the process.

H22A

The H22A resistor is similar in application and adjustment to the H21A except its use is for zero-shift-versus-temperature compensation. Setting the H22A resistance value is readily accomplished by calculating its adjustment influence on bridge zero balance after conducting zero-versus- temperature testing of the completed transducer.

Resistance calculation formulas are available upon request.

M-Line Accessories For Transducer Applications

Surface Cleaning Supplies	78
M-Bond 610	80
M-Bond 43-B for Transducers.....	82
M-Bond 450	83
Installation Tools.....	84
Bondable Terminals.....	87
Solders and Accessories.....	89
Wire, Cable and Accessories	91
M-Coat A.....	96
M-Coat B.....	97
M-Coat C.....	98
M-Coat D.....	99
M-Coat FBT.....	100
M-Coat W-1.....	101
3140 RTV	102
3145 RTV	103
TAK-610 Kit	104
TransCalc™ Software.....	105

Selection Guide for Transducer Applications

MATERIALS LIST

- Solvent cleaners
- Water-based cleaners
- Surface-abrasion materials
- Special-purpose materials

For proper bonding of strain gages and compensation resistors, the surface of the transducer must be chemically clean and totally free of contaminants before applying the adhesive. Instruction Bulletin B-130 lists applicable cleaning materials and techniques for the use of M-Bond 610 and 43-B adhesives. For surface cleaning in “production-line” transducer manufacturing, refer to alternate cleaning procedures outlined in Micro-Measurements publication, “Strain Gage Installation Procedures for Transducers,” a copy of which is available upon request.



SOLVENT CLEANERS	
MODEL/PART NO.	TYPE/DESCRIPTION
CSM-3	Degreaser: A powerful environmentally friendly degreaser. Readily attacks general-purpose lubricating and hydraulic oils. Non-flammable. 20-oz (0.56-kg) pressured spray can. Dispensing solvents from “one way” containers prevents contamination buildup.
GC-6	Isopropyl Alcohol: Frequently used as a solvent degreaser where other solutions are restricted. Flammable. 4-oz (120-ml) bottle.

WATER-BASED CLEANERS	
MODEL/PART NO.	TYPE/DESCRIPTION
Conditioner A: A mild phosphoric acid compound. Acts as a mild etchant and accelerates the cleaning process.	
MCA-1	2-oz* (60-ml) plastic squeeze bottle with on/off dispenser nozzle cap.
MCA-2	Same as MCA-1 except 16 oz (0.5l).
Neutralizer 5A: An ammonia-based material. Neutralizes any chemical reaction introduced by Conditioner A, and produces optimum surface conditions for most strain gage adhesives.	
MN5A-1	2-oz* (60-ml) plastic squeeze bottle with on/off dispenser nozzle bottle cap.
MN5A-2	Same as MN5A-1 except 16 oz (0.5l).

*Note: The 2-oz (60-ml) size is recommended for bench use and is easily refilled from the 16-oz (0.5-l) bottle.

Selection Guide for Transducer Applications

SURFACE-ABRASION MATERIALS	
Abrading is often necessary to dislodge contaminants and to remove rust, scale, etc. When grit-blasting, use fine alumina powder and high-quality filters, and never recycle used grit. Silicon-carbide paper may be used as an alternate to grit blasting.	
MODEL/PART NO.	TYPE/DESCRIPTION
SCP-1	220-grit Silicon-Carbide Paper: Suited to most steels. 1 in x 100 ft (25 mm x 30 m) roll.
SCP-2	320-grit Silicon-Carbide Paper: Suited to most steels. Also suited to aluminum alloys and other soft metals. 1 in x 100 ft (25 mm x 30 m) roll.
SCP-3	400-grit Silicon-Carbide Paper: Suited to aluminum alloys and other soft metals. 1 in x 100 ft (25 mm x 30 m) roll.
GC-5	Pumice Powder: Produces a dull, matte finish. Recommended for minimal removal of surface material. 1/2 oz (15 ml) bottle.

SPECIAL-PURPOSE MATERIALS	
MODEL/PART NO.	TYPE/DESCRIPTION
CSP-1	Cotton Tip Applicators: 100 single-ended applicators per package [6 in (150 mm) long, wooden stick].
GSP-1	Gauze Sponges: 200 sponges [3 x 3 in (75 x 75 mm)] per package.

Strain Gage Adhesive for Stress Analysis and Transducer Applications

OTHER ACCESSORIES USED IN AN M-BOND 610 INSTALLATION:

- CSM Degreaser or GC-6 Isopropyl Alcohol
- Silicon-Carbide Paper
- M-Prep Conditioner A
- M-Prep Neutralizer 5A
- GSP-1 Gauze Sponges
- CSP-1 Cotton Tip Applicators
- MJG-2 Mylar® Tape
- TFE-1 Teflon® Film
- HSC Spring Clamp
- GT-14 Pressure Pads and Backup Plates



RoHS
COMPLIANT

DESCRIPTION

Two-component, solvent-thinned, epoxy-phenolic adhesive for high-performance applications, including high-precision transducers. Solids content 22%. Widest temperature range general-purpose adhesive available.

Low viscosity, capable of gluelines <0.0002 in (0.005 mm). Extremely thin, hard, void-free gluelines minimize creep, hysteresis, and linearity problems. Cure must begin within four hours of application.

CHARACTERISTICS	
PARAMETER	DETAILS
OPERATING TEMPERATURE RANGE	Short Term: -452° to +700°F (-269° to +370°C). Long Term: -452° to +500°F (-269° to +260°C). Transducers: to +450°F (+232°C).
ELONGATION CAPABILITIES	1% at -452° (-269°C), 3% at +75°F (+24°C), 3% at +500°F (+260°C).
SHELF LIFE	Minimum 9 months from date of manufacture on the label when stored unmixed at +75°F (+24°C); or minimum 15 months from the date of manufacture on the label when stored unmixed refrigerated upon receipt at +40°F (+5°C). Refrigerated storage recommended. Refer to product label.
POT LIFE	6 weeks at +75°F (+24°C); 12 weeks at +40°F (+5°C).
CLAMPING PRESSURE	10 to 70 psi (70 to 480 kN/m ²) Optimum: 30 to 40 psi (200 to 275 kN/m ²)
CURE REQUIREMENTS* FOR STRESS ANALYSIS	<div style="display: flex; align-items: center;"> <div style="flex: 1;"> </div> <div style="flex: 1; padding-left: 20px;"> <p>Recommended Postcure: 2 hours at 50° to 75°F (30° to 40°C) above maximum operating temperature or cure temperature, whichever is higher.</p> </div> </div>
CURE REQUIREMENTS* FOR TRANSDUCERS	<p>Recommended Cure: *1 hour at +350°F (+177°C).</p> <p>Transducer Postcure: 2 hours at +400° to +450°F (+205° to +232°C) after wiring.</p> <p>*Altered for aluminum-alloy transducers. See Strain Gage Installation Procedures for Transducers.</p>

* **Reference:** Instruction Bulletin B-130 for complete details.

Strain Gage Adhesive for Stress Analysis and Transducer Applications

PACKAGING	
KIT	SINGLE MIX KIT
4 bottles (11 g ea) Curing Agent 4 bottles (14 g ea) Resin 4 brush caps for dispensing mixed adhesive 4 disposable mixing funnels	1 bottle (11 g ea) Curing Agent 1 bottle (14 g ea) Resin 1 brush cap for dispensing mixed adhesive 1 disposable mixing funnel

References: Instruction Bulletin B-130, "Strain Gage Installations with M-Bond 43-B, 600 and 610 Adhesive Systems," included in each kit.

Strain Gage Adhesive for Transducer Applications

OTHER ACCESSORIES USED IN AN M-BOND 43-B INSTALLATION:

- CSM Degreaser or GC-6 Isopropyl Alcohol
- Silicon-Carbide Paper
- M-Prep Conditioner A
- M-Prep Neutralizer 5A
- GSP-1 Gauze Sponges
- CSP-1 Cotton Applicators
- MJG-2 Mylar® Tape
- TFE-1 Teflon® Film
- HSC Spring Clamp
- GT-14 Pressure Pads and Backup Plates



**RoHS
COMPLIANT**



DESCRIPTION

Single-component, solvent-thinned, epoxy adhesive commonly used in transducer applications; solids content 25%. May be used both as an adhesive and as a protective coating. Capable of forming very thin, hard, void-free gluelines similar to M-Bond 610. Highly resistant to moisture and chemical attack.

CHARACTERISTICS	
PARAMETER	DETAILS
OPERATING TEMPERATURE RANGE	-452° to +250°F (-269° to +120°C)
SHELF LIFE	9 months at +75°F (+24°C); 18 months at +40°F (+5°C)
POT LIFE	9 months at +75°F (+24°C); 18 months at +40°F (+5°C)
CLAMPING PRESSURE	45 to 60 psi (3 to 4 bar); 50 psi (3.4 bar) optimum
CURE REQUIREMENTS	<p>Recommended Cure: 2 hours at +375°F (+190°C)</p> <p>Recommended Postcure: 2 hours at +400° (+205°C)</p>

PACKAGING
KIT
4 brush-cap bottles (30 ml ea) premixed adhesive

Strain Gage Adhesive for Transducer Applications

OTHER ACCESSORIES USED IN AN M-BOND 450 INSTALLATION:

- CSM Degreaser or GC-6 Isopropyl Alcohol
- Silicon-Carbide Paper
- M-Prep Conditioner A
- M-Prep Neutralizer 5A
- GSP-1 Gauze Sponges
- CSP-1 Cotton Applicators
- MJG-2 Mylar® Tape
- TFE-1 Teflon® Film
- HSC Spring Clamp
- GT-14 Pressure Pads and Backup Plates



M-Bond 450



RoHS
COMPLIANT

DESCRIPTION

High-performance, two-component, solvent-thinned epoxy system specially formulated for high accuracy, elevated-temperature transducer applications.

CHARACTERISTICS	
PARAMETER	DETAILS
OPERATING TEMPERATURE RANGE	Short Term: -452° to +750°F (-269° to +400°C) Long Term: -452° to +500°F (-269° to +260°C)
SHELF LIFE	6 months at +75°F (+24°C)
POT LIFE	6 weeks at +75°F (+24°C)
CLAMPING PRESSURE	60 to 100 psi (4 to 6 bar)
CURE REQUIREMENTS	Step 1: Air dry at +75°F (+24°C) 10 to 30 min B-Stage: +225°F (+105°C) for 30 min Cure: +350°F (+175°C) for 1 hour Recommended Postcure: 1 hour at 50°F (30°C) above max operating temperature

PACKAGING
KIT
4 bottles (12.7 g ea) Curing Agent 4 bottles (11.9 g ea) Resin 4 brush caps for applying adhesive 4 disposable mixing funnels

REFERENCES

M-M Instruction Bulletin B-130, "Strain Gage Installations with M-Bond 43-B, 600, and 610 Adhesive Systems".
 M-M Instruction Bulletin B-152, "Instructions for the Application of Micro-Measurements M-Bond 450 Adhesive".
 M-M Strain Gage Accessories databook.

General Information and Selection for Transducer Applications

There is a strong element of craftsmanship involved in making consistently successful strain gage installations. As for any other field, this craft has its own special tools and working materials—found over time by seasoned professionals to be most effective for achieving the desired results. The installation accessories described on this and the following pages represent the distillation of many years' experience in determining the most appropriate tool or material for each task in the gage installation process.

Every accessory item listed here has been thoroughly tested and evaluated in the Micro-Measurements Applications Engineering Laboratory for quality and reliability, for ease of use, and for compatibility with all other Micro-Measurements products. It should be noted that the instruction bulletins supplied for gages, adhesives, protective coatings, etc. assume the availability of these accessories to the user, since such is generally the case for an experienced practitioner in a well-equipped laboratory.

TOOLS	
	<p>SSH-1 SURGICAL SHEARS: Chromium steel, 4-1/2 in (115 mm) long, with one sharp pointed blade and one blunt-end blade.</p> <p>STW-1 TWEEZERS: Stainless steel, 4-1/2 in (115 mm) long. Rugged, precision ground sharp ends. Primarily used for handling leadwires.</p> <p>BTW-1 TWEEZERS: Stainless steel, 4-1/2 in (115 mm) long. Antimagnetic; acid and corrosion resistant. Thin, flat blunt ends ideal for safe handling of strain gages.</p> <p>DPR-1 DENTAL PROBE: Stainless steel "pick". Flexible 75° pointed tip.</p> <p>SSC-1 SURGICAL SCALPEL AND BLADE: Stainless steel, uses SSC-2 snap-in replacement blade.</p>
	<p>SSC-2 REPLACEMENT SCALPEL BLADES: Five blades per package. Not shown.</p> <p>SSS-1 STEEL SCALE: 6 in (150 mm) long, satin-chromed finish. Graduated in inches (1/32, 1/64, 1/10, 1/100).</p> <p>SSS-2 STEEL SCALE: 6 in (150 mm) long, satin-chromed finish. Graduated in inches (1/10, 1/100) and millimeters (0.5, 1).</p> <p>DP-1 4-H DRAFTING PENCIL: For gage layout.</p> <p>DWC-1 DIAGONAL CUTTERS: Stainless steel, 4-1/2 in (115 mm) long, precision cutter for wire up to AWG No. 18 (1 mm diameter).</p> <p>NNP-1 NEEDLE-NOSED PLIERS: Nickel-chrome plated, 4-1/2 in (115 mm) long, with serrated needle-nosed jaws.</p>
<p>SSH-1 STW-1 BTW-1 DPR-1 SSC-1</p> <p>SSS-1 SSS-2 DP-1 DWC-1 NNP-1</p>	<p>ATS-2 GAGE APPLICATION TOOL SET: Includes one of each item plus one additional DPR-1 Dental Probe. Durable, polypropylene box. Not shown.</p>

General Information and Selection for Transducer Applications

TOOLS



GT-11

SPT-1

SPT-2

GT-11 CAMEL'S HAIR BRUSH

318 in (9.5 mm).

SPT-1 STAINLESS STEEL MIXING SPATULA

Double blade. Overall length 8 in (200 mm).

SPT-2 STAINLESS STEEL MIXING SPATULA:

Single blade. Overall length 7-3/4 in (195 mm).
Wooden handle.

WTS THERMAL WIRE STRIPPER



WTS-1

The ease and simplicity of operation of the Thermal Wire Stripper make it ideal for most strain gage leadwire stripping. The variable heat control allows stripping of all thermoplastic insulations, including Teflon®, in sizes No. 18 to No. 36 AWG (1 to 0.1 mm diameter). The foot switch and tweezer handpiece give excellent operator control over the stripping operation. Includes power unit and foot switch, both with 3-wire NEMA plugs, and tweezer handpiece.

WTS-1: 110VAC

WTS-2: 220VAC

WTS-A REPLACEMENT ELEMENTS

Set of two.

General Information and Selection for Transducer Applications

HIGH-TEMPERATURE TAPES & MATERIALS

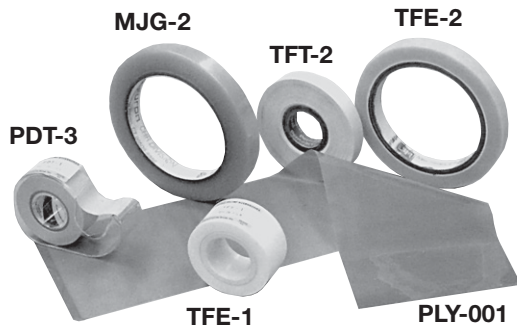

PDT-3 PAPER DRAFTING TAPE:

For soldering mask, and lead positioning. 0.75 in x 400 in (19 mm x 10.1 m).

PLY-001 KAPTON® FILM:

For electrical insulation, 4 x 10 x 0.001 in thick. (100 x 250 x 0.02 mm thick).

MJG-2 MYLAR® TAPE:

For gage handling with heat-curing resin systems. 1/2 in x 216 ft (13 mm x 66 m).

TTF-2 THERMOSETTING [+340°F (+170°C)] FIBERGLASS TAPE:

For electrical insulation at high temperatures. 1/2 in x 180 ft (13 mm x 55 m).

TFE-1 TEFLON FILM:

0.003 in x 1 in x 50 ft (0.08 mm x 25 mm x 15 m).

TFE-2 HIGH MODULUS TFE TEFLON® WITH SILICONE MASTIC:

1/2 in x 108 ft (13 mm x 33 m).

CLAMPING SUPPLIES



HSC-1 SPRING CLAMP:

Maximum Opening: 1 in (25 mm).
Maximum Recommended Opening: 1/2 in (13 mm).
Nominal Clamp Force at Recommended Opening: 30 lbf (135 N).

HSC-2 SPRING CLAMP:

Maximum Opening: 2 in (51 mm).
Maximum Recommended Opening: 1 in (25 mm)..
Nominal Clamp Force at Recommended Opening: 25 lbf (110 N).

HSC-3 SPRING CLAMP:

Maximum Opening: 3 in (76 mm).
Maximum Recommended Opening: 1-1/2 in (38 mm).
Nominal Clamp Force at Recommended Opening: 25 lbf (110 N).

GT-12 NEG'ATOR CONSTANT FORCE EXTENSION SPRING CLAMP:

1 x 0.006 x 38 in (25 mm x 0.4 mm x 0.97 m) stainless steel band, drum I.D. 1.16 in (30 mm), 10.6 lb (47 N) load.

TFE-1 TEFLON FILM:

0.003 in x 1 in x 50 ft (0.08 mm x 25 mm x 15 m).

GT-14 PRESSURE PADS AND BACKUP PLATES:

Kit of 12 Silicone Rubber Pads 3/32 x 1/2 x 1-1/4 in (2.5 x 13 x 32 mm), and 12 aluminum plates, 1/8 x 1/2 x 1-1/4 in (3 x 13 x 32 mm).

SGP-1 SILICONE RUBBER:

Three pieces, each 3/32 x 1 x 6 in (2.5 x 25 x 150 mm).

SGP-2 SILICONE RUBBER:

One piece, 3/32 x 6 x 6 in (2.5 x 150 x 150 mm).

Terminal Details and Descriptions

For many types of strain gages (i.e., Micro-Measurements EA-Series), instrument leadwires generally should not be attached directly to the solder tabs of the gage. Instead, the normal practice is to install bondable terminals adjacent to the gage and solder the instrument leadwires to these. Small, flexible jumper wires, curved to form strain relief loops, are then connected from the terminals to the gage solder tabs. The accompanying drawings show typical strain gage terminal installations (see also Application Note TT-603. "The Proper Use of Bondable Terminals in Strain Gage Applications").



RoHS
COMPLIANT

TERMINAL CONSTRUCTION

Micro-Measurements bondable terminals are specially designed for use in strain gage circuits. They are produced from 0.0014-in (0.036-mm) thick, copper foil, laminated on either of two types of backing material. Both backings are readily bondable with strain gage adhesives. Terminals are offered in four different geometries, and in a range of sizes to suit varying gage installation needs.

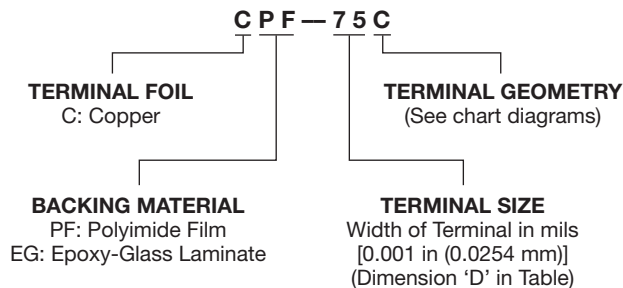

BACKING MATERIALS

TYPE PF POLYIMIDE FILM:





0.003 in (0.08 mm) thick. This is the preferred general-purpose backing material. It is more flexible and conformable than the Type EG, although not as strong. Type PF backing combines high-temperature capability, resistance to soldering damage and good electrical properties. It is suitable for long-term use at +450° to +500°F (+230° to +260°C), limited primarily by gradual oxidation of the copper foil interface. The relatively high thermal expansion coefficient of unfilled polyimide can cause loss of bond at temperatures below -100°F (-75°C).

TYPE EG EPOXY-GLASS LAMINATE:



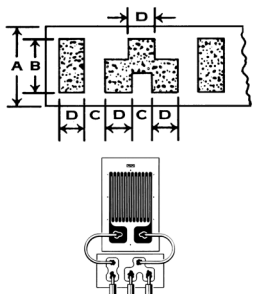

0.005 in (0.13 mm) thick. This special laminate provides a strong but flexible backing for terminals. It is suitable for long-term use at +300°F (+150°C), and is recommended for cryogenic applications at temperatures down to -452°F (-269°C). The radius of curvature of the mounting surface should generally be greater than 1/8 in (3 mm).

Terminal Detail and Description	Terminal Pattern (Actual Size)	Dimensions "A" dimensions nominal				Order Number	Package Strips of 4 Pairs
		A	B	C	D		
<p>Suffix C: General-purpose. Widely used between gage jumper wires and main leadwire system. Suitable for many bridge intraconnection applications.</p>		0.11 (2.7)	0.065 (1.65)	0.025 (0.64)	0.025 (0.64)	CEG-25C CPF-25C	70
		0.14 (3.4)	0.095 (2.41)	0.030 (0.76)	0.038 (0.97)	CEG-38C CPF-38C	60
		0.18 (4.5)	0.125 (3.18)	0.036 (0.91)	0.050 (1.27)	CEG-50C CPF-50C	50
		0.25 (6.4)	0.190 (4.83)	0.040 (1.02)	0.075 (1.91)	CEG-75C CPF-75C	30
		0.33 (8.4)	0.250 (6.35)	0.070 (1.78)	0.100 (2.54)	CEG-100C CPF-100C	20
		0.48 (12.1)	0.375 (9.53)	0.070 (1.78)	0.150 (3.81)	CEG-150C CPF-150C	10

Terminal Details and Descriptions

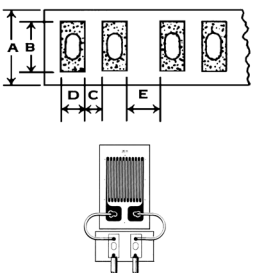
Terminal Detail and Description	Terminal Pattern (Actual Size)	Dimensions "A" dimensions nominal				Order Number	Package Strips of 4 Pairs
		A	B	C	D		
 <p>Suffix D: Designed for installations with 2-wire jumper arrangement to gage and a 3-wire main lead system.</p>		0.18 (4.5)	0.125 (3.18)	0.036 (0.91)	0.050 (1.27)	CEG-50D CPF-50D	30
		0.21 (5.3)	0.150 (3.81)	0.038 (0.97)	0.060 (1.52)	CEG-60D CPF-60D	25
		0.25 (6.4)	0.190 (4.83)	0.040 (1.02)	0.075 (1.91)	CEG-75D CPF-75D	20
		0.33 (8.4)	0.250 (6.35)	0.050 (1.27)	0.100 (2.54)	CEG-100D CPF-100D	15

Terminal Assortment	Order Number	Package Strips of 4 Pairs
Contains 2 strips of C and D patterns, except 1 strip of the 150C and 100D designs	CPF-AST	18

Terminal Detail and Description	Terminal Pattern (Actual Size)	Dimensions "A" dimensions nominal					Order Number	Package Pairs
		A	B	C	D	E		
 <p>Suffix S: Primarily used where soldering and desoldering may be encountered. Hole in center produces thermal isolation at each end of terminal. Not recommended for high cyclic endurance. Available only in epoxy-glass backing.</p>		0.13 (3.2)	0.063 (1.60)	0.021 (0.53)	0.021 (0.53)	0.042 (1.07)	CEG-21S	200
		0.21 (5.2)	0.125 (3.18)	0.042 (1.07)	0.042 (1.07)	0.084 (2.13)	CEG-42S	100
		0.29 (7.4)	0.190 (4.83)	0.063 (1.60)	0.063 (1.60)	0.126 (3.20)	CEG-63S	100
		0.37 (9.4)	0.250 (6.35)	0.083 (2.11)	0.083 (2.11)	0.166 (4.22)	CEG-83S	60

**Solders, Fluxes, Kits, and Soldering
Units for Transducer Applications**

The quality of the solder joints is a critical element in the performance of any strain gage installation. Because of special requirements associated with strain gage circuitry, many commercial soldering stations, solders and fluxes are not satisfactory for this purpose. Micro-Measurements stocks and distributes two special soldering stations, a selection of solders, and soldering fluxes which have been carefully tested and qualified for use with strain gages. See Micro-Measurements Strain Gage Accessories databook for additional solder types available for special applications.

SOLDERS

M-LINE strain gage solders are listed below, along with their compositions and principal properties. For ordering purposes, the solders are specified according to the coding system shown below. All solders listed are supplied on spools.

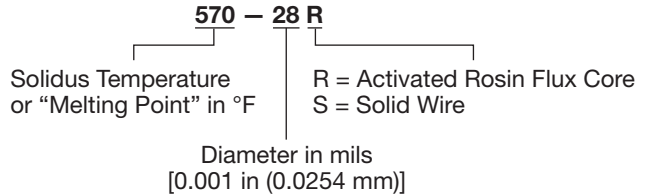

SOLDER SELECTION CHART				
Solder Type (See Note 1)	Packaging		Solidus/ Liquidus Temperature	Dia.
	Order No.	Unit Size		
361A-20R 63% Tin, 36.65% Lead, 0.35% Antimony	361A-20R-25	25 ft (7.6m)	361°/361°F (183°/183°C)	0.020
	361A-20R	1 lb (450g)		
450-20S 95% Tin, 5% Antimony	450-20S-25	25 ft (7.6m)	450°/460°F (232°/238°C)	0.020
	450-20S	1 lb (450g)		
450-20R 95% Tin, 5% Antimony	450-20R-25	25 ft (7.6m)	450°/460°F (232°/238°C)	0.020
	450-20R	1 lb (450g)		
570-28R 93% Lead, 5.2% Tin, 1.5% Silver	570-28R-20	20 ft (6.1m)	565°/574°F (296°/301°C)	0.028
	570-28R	1 lb (450g)		

Note 1: Products shown in bold are not RoHS compliant.

FLUXES

Although some of the solders described in the table have rosin-flux cores, it is often necessary to use separate, externally applied fluxes. This may be the case, for instance, when soldering fine jumper wires to gage tabs or printed-circuit terminals, because not enough flux is released from the cored solder. It may also be necessary to supplement the cored flux in high-temperature solders such as Type 570.

Two fluxing compounds are available for strain gage soldering applications. M-Flux AR is an activated rosin flux which is effective on constantan, copper, nickel, and K-alloy gages with DP soldering pads. M-Flux SS is a very active acid flux which is used primarily with solid-wire solders applied to isoelastic, Nichrome®, and stainless steel. The two fluxes should never be mixed. Whether the rosin or acid flux is used, it must be completely removed immediately after soldering to prevent degradation of

protective coatings and corrosion of the metals, and to eliminate conductive flux residues. Rosin residues are best removed with *M-LINE* Rosin Solvent. Removal of M-Flux SS requires two steps: liberal applications of M-Prep Conditioner A, which must be blotted dry; and then M-Prep Neutralizer 5A, also to be blotted dry.

FLUX AND ROSIN SOLVENT KITS
M-Flux AR Kit FAR-2
2 1-oz (30-ml) brush-cap bottles M-Flux AR 2 1-oz (30-ml) brush-cap bottles M-LINE Rosin Solvent
M-LINE Rosin Solvent Kit RSK-4
4 1-oz (30-ml) brush-cap bottles
M-Flux SS Kit FSS-1
1 1-oz (30-ml) applicator cap bottle M-Flux SS1 1-oz (30-ml) brush-cap bottle M-Prep Conditioner A 1 1-oz (30-ml) brush-cap bottle M-Prep Neutralizer 5A

Solders, Fluxes, Kits, and Soldering Units for Transducer Applications

MARK IX SOLDERING STATION



Manufactured for Micro-Measurements, the Mark IX is a compact soldering unit with a lightweight soldering pencil. The modular design of the pencil allows for easy changing of tips, and heating element replacement. Includes both the M9S-A and M9S-B soldering tips, selected for ease of use with strain gages. The Mark IX incorporates closed-loop control technology for precise tip temperature management. Tip temperature range of +500° to +800°F (+260° to +425°C) is ideal for most laboratory and field strain gage applications. The temperature control is color-coded for proper tip temperatures for all Micro-Measurements soft solders. Not or use with Type 1240-FPA solder.

M9S-1-115 MARK IX SOLDERING UNIT,

M9S-1-230 MARK IX SOLDERING UNIT,

Complete, XXX = Voltage 115 or 230 (Vac).

M9S-1-230-CE MARK IX

Soldering Unit, Complete, Voltage 230, CE Version

SOLDERING TIPS FOR MARK IX

M9S-A Narrow tip 0.047 in (1.2 mm) screwdriver.

M9S-B Wide tip 0.062 in (1.6 mm) screwdriver.

M9S-RS Replacement Sponge, package of 1.

General Information and Selection

Different strain gage installation conditions and test specifications often necessitate the use of different types or sizes of leadwires. For accurate, reliable strain measurements, it is important to use an appropriate type of leadwire for each installation. Micro-Measurements stocks a wide variety of wires and cables, cataloged in tabular form on the following pages. All wires and cables listed in the tables have been proven in the field to give excellent sensor performance when properly used in the specified environments. Special gage wiring problems may require the use of wires not listed here. In such cases, our Applications Engineering Department can recommend appropriate wire types and can suggest suppliers.



WIRE AND CABLE CODING SYSTEM

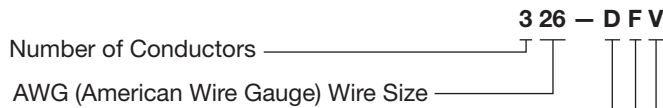

Types of Wire

- A:** Solid copper
- B:** Stranded copper
- D:** Tinned stranded copper
- F:** Silver-plated stranded
- G:** Nickel-clad solid copper
- H:** Solid Manganin
- J:** Solid Balco®

Construction

- F:** Flat cable
- J:** Twisted cable with jacket
- S:** Shielded/twisted with jacket
- T:** Twisted cable without jacket
- W:** Round single wire

Insulation

- E:** Etched TFE Teflon®
- F:** Fiberglass braid
- K:** Kapton® (polyimide) wrap
- N:** Nylon/polyurethane enamel
- P:** Polyurethane enamel
- Q:** Polyimide enamel
- T:** TFE Teflon®
- V:** Vinyl (PVC)

AWG	Diameter (nominal)		AWG	Diameter (nominal)	
	in	(mm)		in	(mm)
22	0.0253	0.643	34	0.0063	0.160
26	0.0159	0.404	36	0.0050	0.127
27	0.0142	0.361	37	0.0045	0.114
30	0.0100	0.254	42	0.0025	0.064

Balco is a Registered Trademark of W.B. Driver Company. Teflon and Kapton are Registered Trademarks of DuPont.

*Solid core wire

RIBBON WIRE CODING SYSTEM

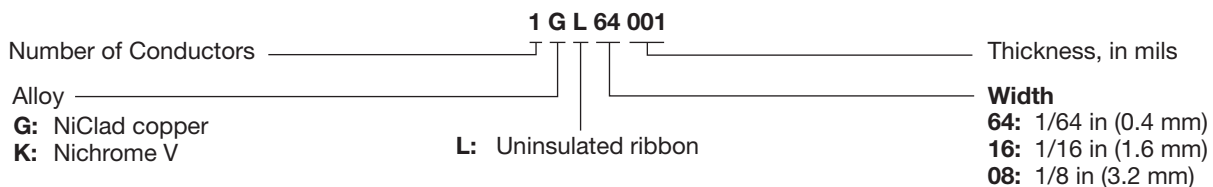

The Wire and Cable Coding System shown above gives the unique designation of each wire type for ordering purposes. The leadwire and cabling selection charts presented on the next three pages are organized

according to the number of conductors. All wires and cables are supplied on spools for user convenience. Some styles may not be continuous length.

References:

- Application Note: TT-601, Techniques for Bonding Leadwires to Surfaces Experiencing High Centrifugal Forces.
- Application Note: TT-604, Leadwire Attachment Techniques for Obtaining Maximum Fatigue Life of Strain Gages.
- Application Note: TT-608, Techniques for Attaching Leadwires to Unbonded Strain Gages.







General Information and Selection

		SINGLE-CONDUCTOR TYPES: SOLID WIRE		
		Type	Packaging Foot (Meter)*	Description
<p>AWP AWN</p> <p>AWQ GWF</p> <p>HWN JWN</p>	134-AWP 136-AWP	500 ft (150 m) 500 ft (150 m)	Solid copper wire, polyurethane enamel: General-purpose intragage hookup wire. Useful from -100° to +300°F (-75° to +150°C). Enamel coating easily removed by applying heat from soldering iron.	<p>RoHS COMPLIANT</p>
	127-AWN 130-AWN 134-AWN 136-AWN	500 ft (150 m) 500 ft (150 m) 500 ft (150 m) 500 ft (150 m)	Solid copper wire, nylon/polyurethane enamel: Identical in use and specifications to Type AWP above, but with superior abrasion resistance and slightly reduced insulation resistance at elevated temperatures. 134-AWN and 136-AWN are available in four colors; specify: -R (red), -W (white), -B (black), -G (green).	
	127-AWQ 130-AWQ 134-AWQ	500 ft (150 m) 500 ft (150 m) 500 ft (150 m)	Solid copper wire, polyimide enamel: Intragage hookup wire. Temperature range -452° to +600°F (-269° to +315°C) short term. Enamel is extremely tough and abrasion resistant, with excellent electrical properties; generally removed by mechanical scraping or sanding.	
	126-GWF 126-GWF	100 ft (30 m) 1000 ft (300 m)	Solid nickel-clad copper wire, fiberglass braid insulation: Useful from -452° to +900°F (-269° to +480°C). Recommended for use with WK-Series gages when silver solder is used for lead attachment.	
	137-HWN	200 ft (60 m)	Solid manganin wire, nylon/polyurethane enamel: Used for bridge balance and span set in transducer circuits. Nominal resistance: 14 ohms/ft (50 ohms/m). Temperature range: +10° to +125°F (-10° to +50°C).	
	142-JWN	500 ft (150 m)	Solid Balco® wire, nylon/polyurethane enamel: Used for bridge temperature compensation of zero shift or span. Nominal resistance: 19 ohms/ft (65 ohms/m). Temperature coefficient of resistance: +0.25%/°F (+0.45%/°C). Temperature range: +10° to +300°F (-10° to +150°C).	
		SINGLE-CONDUCTOR TYPES: STRANDED WIRE		
		Type	Packaging Foot (Meter)*	Description
<p>DWV FWK FWT</p>	126-DWV	100 ft (30 m)	Stranded tinned-copper wire, vinyl insulation: General-purpose leadwire. Useful to +180°F (+80°C). Vinyl insulation becomes brittle at low temperature; not normally used below -60°F (-50°C). Specify red, white, black, or green.	<p>RoHS COMPLIANT</p>
	126-FWK	25 ft (7.5 m)	Stranded silver-plated copper wire, Kapton® polyimide insulation: High- performance. Recommended for unusually severe service from -452° to over +600°F (-269° to +315°C) short term. Excellent resistance to abrasion, radiation, and outgassing in high vacuum. Treated for bondability.	
	130-FWT	100 ft (30 m)	Stranded silver-plated copper wire, Teflon® insulation: Wide temperature range. Useful from -452° to +500°F (-269° to +260°C). When bonding to Teflon-insulated wire, insulation must be treated with Tetra-Etch® compound (see "Special-Purpose Materials.") Specify red, white, black, or green.	

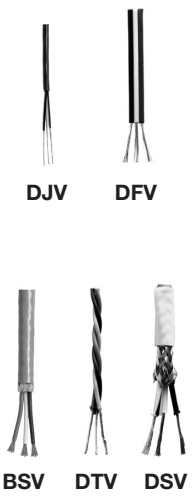
*Some types may not be continuous length.

Balco is a Registered Trademark of W.B. Driver Company.
 Kapton and Teflon are Registered Trademarks of DuPont.
 TetraEtch is a Registered Trademark of W.L. Gore.











General Information and Selection

		THREE-CONDUCTOR CABLE		Description	
		Type	Packaging Foot (Meter)*		
 <p>DJV DFV BSV DTV DSV</p>	322-DJV	500 ft (150 m)	Stranded tinned-copper wire, 3-conductor twisted cable, chrome PVC vinyl jacket, vinyl insulation: Good choice for use with EGP-Series Embedment Strain Gages. Color-coded red/white/black.	 RoHS COMPLIANT	
	326-DFV 326-DFV 330-DFV 330-DFV	100 ft (30 m) 1000 ft (300 m) 100 ft (30 m) 1000 ft (300 m)	Stranded tinned-copper wire, 3-conductor flat cable, vinyl insulation: Convenient general-purpose cable. For use from -60° to +180°F (-50° to +80°C). Flat construction requires minimum space. Color-coded red/white/black.		
	326-BSV 326-BSV	100 ft (30 m) 1000 ft (300 m)	Stranded copper wire, 3-conductor twisted cable, PVC insulated, braided shield: For use from -60° to 180°F (-50° to +80°C).		
	326-DTV 326-DTV	100 ft (30 m) 1000 ft (300 m)	Stranded tinned-copper wire, 3-conductor twisted cable, vinyl insulation: Convenient general-purpose cable for low electrical noise pickup. For use from -60° to +180°F (-50° to +80°C). Color-coded red/white/black.		
	326-DSV 326-DSV	100 ft (30 m) 1000 ft (300 m)	Stranded tinned-copper wire, 3-conductor twisted cable, vinyl insulation, braided shield, vinyl jacket: Special-purpose cable to minimize electrical noise interference. Useful from -60° to +180°F (-50° to +80°C). Color-coded red/white/black.		
 <p>FFE</p>	330-FFE 330-FFE	100 ft (30 m) 1000 ft (300 m)	Stranded silver-plated copper wire, 3-conductor flat cable, etched Teflon® insulation: For use from -452°F to +500°F (-269°C to +260°C). Color-coded red/white/black. Insulation treated for bonding.	 RoHS COMPLIANT	
 <p>FJT FTE GJF</p>	330-FJT 330-FJT	100 ft (30 m) 1000 ft (300 m)	Stranded silver-plated copper wire, 3-conductor twisted cable, Teflon insulation, Teflon jacket: Small, flexible. For use from -452° to +392°F (-269° to +200°C). Color-coded red/white/black. When bonding Teflon-insulated wire, insulation must be treated with Tetra-Etch® compound (see "Special-Purpose Materials.")	 RoHS COMPLIANT	
	336-FTE	50 ft (15 m)	Stranded silver-plated copper wire, 3-conductor twisted cable, etched Teflon insulation: Small, flexible cable. For use from -452° to +500°F (-269° to +260°C). Color-coded red/white/black. Insulation treated for bonding.		
	326-FTE 326-FTE 330-FTE 330-FTE	100 ft (30 m) 500 ft (150 m) 100 ft (30 m) 500 ft (150 m)	Stranded silver-plated copper wire, 3-conductor twisted cable, etched Teflon insulation: For use from -452° to +500°F (-269° to +260°C). Color-coded red/white/black. Insulation treated for bonding.		
	326-GJF 326-GJF	100 ft (30 m) 1000 ft (300 m)	Solid nickel-clad copper wire, 3-conductor twisted cable, fiberglass braid insulation and jacket: For use from -452° to +900°F (-269° to +480°C). Recommended for use with WK-Series gages when silver solder is used for lead attachment. Color-coded red/white/black.		

*Some types may not be continuous length.

Teflon is a Registered Trademark of DuPont.
TetraEtch is a Registered Trademark of W.L. Gore.

General Information and Selection

FOUR-CONDUCTOR CABLE				
Type	Packaging	Description		
	Foot (Meter)*			
 BSV	100 ft (30 m)	Stranded copper wire, 4-conductor twisted cable, PVC insulated braided shield: For use from -60° to +180°F (-50° to +80°C).		
	1000 ft (300 m)			
 DFV	100 ft (30 m)	Stranded tinned-copper wire, 4-conductor flat cable, vinyl insulation: For use from -60° to +180°F (-50° to +80°C). Conductors easily separated for stripping and wiring. Color-coded red/white/black/green.		
	1000 ft (300 m)			
	100 ft (30 m)			
	1000 ft (300 m)			
 DSV	100 ft (30 m)	Stranded tinned-copper wire, 4-conductor polypropylene insulated: Twisted shielded pairs (red/black and white/green) with a drain wire, PVC jacket. For use from -60° to +180°F (-50°C to +80°C).		
	1000 ft (300 m)			
	100 ft (30 m)			
	1000 ft (300 m)			
 DTV	100 ft (30 m)	Stranded tinned-copper wire, 4-conductor twisted cable, vinyl insulation: For use from -60° to +180°F (-50° to +80°C). Color-coded red/white/black/green.		
	1000 ft (300 m)			
 FST	100 ft (30 m)	Stranded silver-plated copper wire, 4-conductor twisted cable, Teflon® insulation, braided shield, Teflon jacket: Small, flexible cable. For use from -452° to +500°F (-269° to +260°C). Color-coded red/white/black/green. When bonding Teflon-insulated wire, insulation must be treated with Tetra-Etch® compound (see Special-Purpose Materials, document number 11008).	 RoHS COMPLIANT	
	1000 ft (300 m)			
 FTE/FTT	100 ft (30 m)	Stranded silver-plated copper wire, 4-conductor twisted cable, etched Teflon insulation: For use from -452° to +500°F (-269° to +260°C). Color-coded red/white/black/green. Insulation treated for bonding.		
	500 ft (150 m)			
 FFT	100 ft (30 m)	Stranded silver-plated copper wire, 4-conductor twisted cable, Teflon® insulation: Small, flexible cable. For use from -452° to +500°F (-269° to +260°C). Color coded red, white, black, green. When bonding Teflon insulated wire, insulation must be treated with Teflon etchant, such as TEC-1 (see Special-Purpose Materials, document number 11008).		
	500 ft (150 m)			
 1-GL-64-001	Type	Packaging	Description	
		Foot (Meter)*		
 1-KL-16-002 1-KL-08-003 1-KL-08-005	1-GL-64-001	50 ft (15 m)	Uninsulated flat ni-clad copper ribbon: 1/64 in wide x 0.001 in thick (0.4 x 0.025 mm). For use from -452 to 900°F (-269 to +480°C). Can be easily soldered or spot welded.	 RoHS COMPLIANT
	1-KL-16-002	50 ft (15 m)	Uninsulated Nichrome V: 1/16 in wide x 0.002 in thick (1.6 x 0.05 mm). For use from -452 to +2000°F (-269 to +1100°C).	
	1-KL-08-003	50 ft (15 m)	Uninsulated Nichrome V: 1/8 in wide x 0.003 in thick (3.2 x 0.08 mm). For use from -452 to +2000°F (-269 to +1100°C).	
	1-KL-08-005	50 ft (15 m)	Uninsulated Nichrome V: 1/8 in wide x 0.005 in thick (3.2 x 0.127 mm). For use from -452 to +2000°F (-269 to +1100°C).	

*Some types may not be continuous length.

Teflon is a Registered Trademark of DuPont.
TetraEtch is a Registered Trademark of W.L. Gore.

General Information and Selection

HST-1 HEAT-SHRINKABLE WIRE SPLICE SEALANT



Fast, easy-to-use method for protecting wire splice connections. Constructed of irradiated polyolefin plastic tubing with a heat-flowable inner liner sealant. Forms an immediate and tight seal to splice connection at a shrink temperature of +275°F (+135°C). Inside diameter before heating is 0.125 in (3.2 mm); after heating, 0.023 in (0.6 mm). Large range of shrinkage allows use with leadwire insulation diameters from 0.03 to 0.11 in (0.75 to 2.8 mm). The operating temperature range is -65° to +230°F (-55° to +110°C). Package of eight 6-in (150-mm) lengths.

THERMAL WIRE STRIPPER



The ease and simplicity of operation of the Thermal Wire Stripper make it ideal for most strain gage leadwire stripping. The variable heat control allows stripping of all thermoplastic insulations, including Teflon®, in sizes No. 18 to No. 36 AWG (1 to 0.1 mm diameter). The foot switch and tweezers hand-piece give excellent operator control over the stripping operation. Includes power unit and foot switch, both with 3-wire NEMA plugs, and tweezers handpiece.

WTS-1: 110 Vac

WTS-2: 220 Vac (not CE rated)

WTS-A Replacement Elements: Set of two.

Teflon is a Registered Trademark of DuPont.

Protective Coating

FEATURES

- Easy to use
- Transparent
- Good general-purpose coating for laboratory use

DESCRIPTION

Air-drying solvent-thinned (xylene) polyurethane. Transparent. Moderate hardness; good flexibility. Can be removed with *M-LINE* Rosin Solvent or toluene. Film thickness 0.005–0.01 in (0.1–0.25 mm) per coat.

General-purpose coating for lab use, and as base coating for field applications. Must be fully cured before addition of other coatings. Fair moisture resistance. Not readily attacked by many solvents. Convenient to use.



RoHS
 COMPLIANT

CHARACTERISTICS	
PARAMETER	DETAILS
CURE REQUIREMENTS	<p>Dries tack-free at room temperature in 20 minutes. Completely dry in 2 hours.</p> <p>Normal cure 24 hours at room temperature. Chemical resistance and coating hardness increase for 6 to 7 days.</p>
OPERATING TEMPERATURE RANGE	<p>Short Term: –100° to +300°F (–75° to +150°C).</p> <p>Long Term: –100° to +250°F (–75° to +120°C).</p>
SHELF LIFE	<p>Minimum 1 year at +75°F (+24°C). Refer to product label for most recent information.</p>

PACKAGING OPTIONS	
KIT	BULK
4 brush-cap bottles [1 oz (30 ml) ea].	Quart container.

Protective Coating

FEATURES

- Good resistance to chemicals
- Air drying
- Also used for priming leadwires



RoHS
COMPLIANT

DESCRIPTION

Air-drying solvent-thinned (MEK) nitrile rubber. Forms flexible rubbery coating. Do not use directly on exposed foil or bare leads. Often used to prime vinyl-insulated wire to improve bondability to other coatings. If used as primer on leads, thin 50:50 with MEK. Flexible at cryogenic temperatures. Excellent resistance to gasoline, kerosene, commercial oils. Electrical properties poorer than other M-Coats, particularly at elevated temperatures.



CHARACTERISTICS	
PARAMETER	DETAILS
CURE REQUIREMENTS	Air-dries in 1 hour at +75°F (+24°C). Do not apply subsequent protective coatings for at least 2 hours from time of application. Normal cure 24 hours at room temperature. Further improve chemical resistance with 1 hour bake at +200°F (+95°C).
OPERATING TEMPERATURE RANGE	Short Term: -320° to +300°F (-195° to +150°C). Long Term: -320° to +200°F (-195° to +95°C).
SHELF LIFE	Minimum 1 year at +75°F (+24°C). Refer to product label for most recent information.

PACKAGING OPTIONS	
KIT	BULK
4 brush-cap bottles [1 oz (30 ml) ea].	Quart container.

Protective Coating

FEATURES

- Air drying
- Low reinforcement
- Transparent

DESCRIPTION

Solvent-thinned (naphtha) RTV silicone rubber. Cures to tough, rubbery transparent film. Good all-around mechanical and electrical properties. Completely noncorrosive. Film thickness 0.015–0.02 in (0.4–0.5 mm) per coat.

Recommended for lab and field installations that require a high degree of protection in thin coatings. Good water-splash protection. Good chemical resistance.



RoHS
 COMPLIANT

CHARACTERISTICS	
PARAMETER	DETAILS
CURE REQUIREMENTS	<p>Solvents evaporate in about 60 minutes at room temperature. Allow 20 minutes drying time between coats.</p> <p>Cures in 24 hours at +75°F (+24°C) and 50% RH. Longer cure at lower humidity.</p>
OPERATING TEMPERATURE RANGE	<p>Short Term: –75° to +550°F (–60° to +290°C).</p> <p>Long Term: –75° to +500°F (–60° to +260°C).</p>
SHELF LIFE	<p>Minimum 9 months at +75°F (+24°C) kept tightly sealed. Refer to product label for most recent information.</p>

PACKAGING OPTIONS	
KIT	BULK
4 brush-cap bottles [1 oz (30 ml) ea].	Quart container.

Protective Coating

FEATURES

- Air drying
- Opaque
- Good base coating

DESCRIPTION

Air-drying solvent-thinned (toluene) acrylic. Dense white color for easy visual inspection of coverage. Forms hard thin coating capable of high elongation. Can be removed with *M-LINE* Rosin Solvent or toluene. Apply in thin coats to prevent solvent entrapment. Film thickness 0.005–0.01 in (0.1–0.25 mm) per coat.

Good general laboratory moisture barrier. Electrical leakage negligible even when uncured. Good base coating for subsequent applications of M-Coat B. Convenient for anchoring and insulating intrabridge wiring and jumper leads. Chemical resistance only fair but can be improved by postcure at +175°F (+80°C) for 30 minutes.



CHARACTERISTICS	
PARAMETER	DETAILS
CURE REQUIREMENTS	<p>Air dry for 15 minutes then cure for 24 hours at +75°F (+24°C) or one hour at +150°F (+65°C).</p> <p>Overcoats can be applied 30 minutes from time of application.</p> <p>Coating binder begins to sublimate at +280°F (+140°C), but residue is inorganic and will not become conductive.</p>
OPERATING TEMPERATURE RANGE	<p>Short Term: –100° to +325°F (–75° to +160°C).</p> <p>Long Term: –100° to +250°F (–75° to +120°C).</p>
SHELF LIFE	<p>Minimum 1 year at +75°F (+24°C) kept tightly sealed. Refer to product label for most recent information.</p>

PACKAGING OPTIONS	
KIT	BULK
4 brush-cap bottles [1 oz (30 ml) ea].	Quart container.

Protective Coating

FEATURES

- Excellent protection from moisture
- Low reinforcement
- Easy to apply



RoHS
 COMPLIANT



DESCRIPTION

Solvent-thinned butyl rubber designed to provide excellent moisture protection with low reinforcement effects. Principally used in transducers. Exhibits a paste-like consistency and is normally applied with a spatula. Thickness over 0.1 in (2.5 mm) not recommended.

CHARACTERISTICS	
PARAMETER	DETAILS
CURE REQUIREMENTS	Air dry 8 hours, followed by an elevated temperature cure of +150° to +175°F (+65° to +80°C) for 4 to 6 hours.
OPERATING TEMPERATURE RANGE	0° to +175°F (-20° to +80°C).
SHELF LIFE	Minimum 12 months at +75°F (+24°C). Refer to product label for most recent information.

PACKAGING OPTIONS	
KIT	BULK
75g collapsible tubes, 4 each	Quart container.

Protective Coating

FEATURES

- Outstanding moisture protection
- Easy to apply
- No cure required

DESCRIPTION

Microcrystalline wax. Has very low water-vapor transmission rate. Attacked by most solvents. Coating thickness 0.015–0.06 in (0.4–1.5 mm).

Excellent water-immersion coating. Poor mechanical protection. Often used as an intermediate coating.



RoHS
COMPLIANT

CHARACTERISTICS	
PARAMETER	DETAILS
APPLICATION REQUIREMENTS	Heat to at least +170°F (+75°C) to melt. For best wetting and sealing, heat specimen surface to at least +100°F (+45°C) before applying. No cure required.
OPERATING TEMPERATURE RANGE	0° to +150°F (–20° to +65°C)
SHELF LIFE	No limit. Store at +75°F (+24°C).

PACKAGING OPTIONS	
PARAMETER	DETAILS
KIT	5 tins [1 oz (28g)]
BULK	1 package [5 lb (2.25 kg)]

Protective Coating

FEATURES

- Easy to use
- Translucent
- Self-leveling
- Room-temperature cure

RoHS
 COMPLIANT

DESCRIPTION

Single-component 98%-solids RTV silicone rubber. Room-temperature cure (humidity-reactive). Completely non-corrosive. Forms tough, rubbery coating. Excellent properties. Translucent; permits full inspection of installation. Self-leveling; forms fairly thick coats 0.03–0.06 in (0.75–1.5 mm).

Easy-to-apply general-purpose coating. Lab and field use. Low reinforcing effects. High-elongation capabilities. Good for short-term water immersion. Resists many chemicals. Bonds to contaminated surfaces for short-term tests; for best long-term protection, chemically clean surface and prime with *M-LINE* RTV Primer No. 1.

CHARACTERISTICS	
PARAMETER	DETAILS
CURE REQUIREMENTS	<p>Tack-free in approximately 2 hours.</p> <p>Cure 24 hours at +75°F (+24°C), 50% RH for each 0.02-in (0.5-mm) thickness. Longer cure at lower humidity levels.</p> <p>Note: Will not cure properly if coating is not exposed to atmosphere.</p>
OPERATING TEMPERATURE RANGE	–49°F to +392°F (–45°C to +200°C).
SHELF LIFE	Minimum 6 months at +75°F (+24°C). Refer to product label for most recent information..

PACKAGING OPTIONS	
KIT	OPTIONAL PRIMER
1 collapsible metal tube [3 oz (85g)]	4 brush-cap bottles [1 oz (30 ml) ea] RTV Primer No. 1

Protective Coating

FEATURES

- Easy to use
- Good mechanical protection
- Good cable anchor
- Room-temperature cure

DESCRIPTION

Single-component 98%-solids RTV silicone rubber. Room temperature cure (humidity-reactive). Completely non-corrosive. Forms tough, rubbery coating. Excellent properties. Opaque gray coating of higher strength and toughness than 3140 RTV. Not self-leveling.

Easy-to-apply general-purpose coating. Lab and field use. Low reinforcing effects. High-elongation capabilities. Good for short-term water immersion. Resists many chemicals. Bonds to contaminated surfaces for short-



RoHS
COMPLIANT

term tests; for best long-term protection, chemically clean surface and prime with *M-LINE* RTV Primer No. 1. Very thick coatings can be applied without sag or runoff. Tear strength much higher than 3140. Good cable anchor.

CHARACTERISTICS	
PARAMETER	DETAILS
CURE REQUIREMENTS	Tack-free in approximately 2 hours. Cure 24 hours at +75°F (+24°C), 50% RH for each 0.02-in (0.5-mm) thickness. Longer cure at lower humidity levels. Note: Will not cure properly if coating is not exposed to atmosphere.
OPERATING TEMPERATURE RANGE	-49°F to +392°F (-45°C to +200°C).
SHELF LIFE	Minimum 6 months at +75°F (+24°C). Refer to product label for most recent information.

PACKAGING OPTIONS	
KIT	OPTIONAL PRIMER
1 collapsible metal tube [3 oz (85g)]	4 brush-cap bottles [1 oz (30 ml) ea] RTV Primer No. 1

Strain Gage Application Kit for Transducers

It is often of greatest convenience for the strain gage user to purchase all of the needed accessory supplies and materials in a single package. For this purpose, Micro-Measurements offers the TAK-610 Strain Gage Application Kit. Kit contents, including our CSM Degreaser, are available separately. Refer to the appropriate sections of this catalog for specific component details.

TAK-610 KIT CONTENTS

- M-Bond 610 Kit
- MCA-1 Conditioner A, 1 bottle
- MN5A-1 Neutralizer 5A, 1 bottle
- SCP-1 220 grit, 1 roll, 100 ft (30 m)
- SCP-2 320 grit, 1 roll, 100 ft (30 m)
- SCP-3 400 grit, 1 roll, 100 ft (30 m)
- CSP-1 Cotton Swabs, 1 package
- GSP-1 Gauze Sponges, 1 package
- MJG-2 Mylar Tape, 1 roll
- PDT-3 Paper Drafting Tape, 1 roll
- 361A-20R-25 Solder, 1 roll, 25 ft (7.6 m)
- FAR-2 M-Flux AR Kit
- CPF-AST Bondable Terminals, 1 box
- 426-DFV, 4-Conductor Leadwire, 100 ft (30 m)
- M-Coat C, 1 oz (30 ml)
- 134-AWP Solid Copper Wire, 500 ft (150 m)
- SGP-2 Silicone Rubber, 1 piece
- HSC-1 No. 1 Spring Clamp, 4 each
- TFE-1 Teflon Film, 1 roll
- BTW-1 Blunt-Nose Tweezers
- Plastic Tool Box



Transducer Application Software

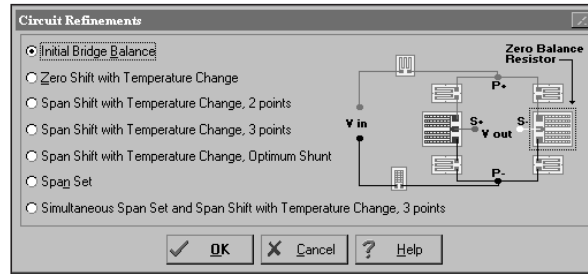
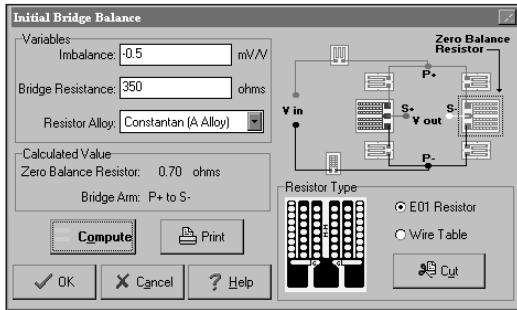

TransCalc™ is a valuable resource for the transducer designer, providing:

- Design verification calculations of surface strain, strain variation, and bridge output for 15 common transducer shapes; user-selectable US Customary or SI units.
- Circuit refinement computations of zero balance, zero-shift-with-temperature change, span-shift-with-temperature change, and span set.
- Interactive graphical resistor-adjustment guidelines.
- Intuitive Windows® user interface.
- Built-in wire tables for computing length or resistance of wire necessary for the transducer circuit.
- Calculation of bridge outputs for six different Wheatstone-bridge configurations.
- In-depth reference material for:
 - Spring element design considerations
 - Resistor selection guidelines
 - Materials properties
 - Bridge adjustment and compensation circuitry

*Windows is a registered trademark of Microsoft Corporation in the United States and other countries.



Contact

mm@vpgsensors.com

micro-measurements.com